

**THE**



**SERIES MGA**

**DRIVER'S HANDBOOK**



THE



(Series MGA)

# DRIVER'S HANDBOOK

EIGHTH EDITION

A copy of this Driver's Handbook is sent out with every M.G. (Series MGA) car. Additional copies are obtainable only from your M.G. Distributor and Part No. AKD598G should be quoted when ordering.

Published by

**THE M.G. CAR COMPANY LIMITED**

*Proprietors: Morris Motors Ltd.*

**ABINGDON-ON-THAMES**

*Telephone: Abingdon 251-2-3-4*

*Telegrams: Emgee, Abingdon*

Sole Exporters

**NUFFIELD EXPORTS LIMITED**

*Proprietors: Morris Motors Ltd.*

**COWLEY - OXFORD - ENGLAND**

*Telephone: Oxford, England, 77733*

*Telex: Morex, Oxford, England*

*Cables: Morex, Oxford, England*

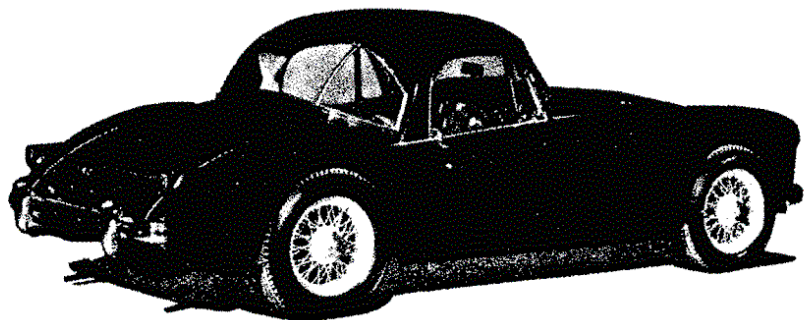

THE M.G. TWO-SEATER COUPÉ (Series MGA)

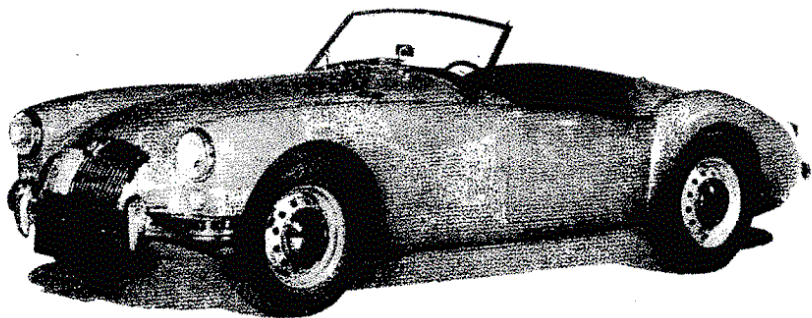

THE M.G. TWO-SEATER (Series MGA)

## FOREWORD

**T**HE information contained in this Driver's Handbook has been confined to the essentials required for the proper running and driving of the car. Nevertheless, the owner will find all the information required to maintain the car in first-class condition and to enable him to give it those all-important items of attention which go so far to ensure trouble-free and satisfactory service.

Every M.G. car leaving the Works is capable of giving absolute satisfaction if attention is given to the essential maintenance operations detailed in this book. Remember that M.G. Distributors/Dealers are better equipped to provide routine and repair service than the owner-driver; therefore, if you encounter trouble consult the Distributor or Dealer or the Service Department of The M.G. Car Company Limited—they are at your service.

An exchange scheme for many major items and assemblies is run by B.M.C. Service Limited; ask your Distributor or Dealer for details.

For those requiring information of a more detailed and technical nature than is contained in the Driver's Handbook, a Workshop Manual is available at a reasonable price from your Distributor or Dealer.

### IDENTIFICATION

When communicating with the Company or your Distributor/Dealer always quote the car and engine numbers; the registration number is of no use and is not required.

Note that all correspondence concerning exported cars must be addressed to Nuffield Exports Limited.

**Car number.** Stamped on a plate mounted on the engine bulkhead shelf.

**Engine number.** On a metal plate fixed to the right-hand side of the cylinder block.

The engine number comprises a series of letters and numbers, presenting, in code, the capacity, make, and type of unit, ancillaries fitted, and the type of compression, together with the serial number of the unit.

The major components of this vehicle also have serial numbers and should it be necessary to quote them at any time they will be found in the following locations:

**Gearbox.** Stamped on the top of the gearbox to the left of the dipstick and filler plug.

**Rear axle.** Stamped on the front of the axle tube on the left-hand side adjacent to the spring seat.

**Body.** Stamped on a metal plate fixed to the bulkhead and situated between the right-hand bonnet hinge and the fuse unit.

## GENERAL DATA

Engine .. .. .	4-cylinder overhead-valve
Bore .. .. .	2.875 in. (73.025 mm.)
Stroke .. .. .	3.5 in. (88.9 mm.)
Capacity .. .. .	1489 c.c. (90.88 cu. in.)
Compression ratio .. .. .	8.3 : 1
Firing order .. .. .	1, 3, 4, 2
Valve clearance .. .. .	.017 in. (.43 mm.) (hot)
Sparking plugs .. .. .	Champion N5 (formerly NA8), 14 mm., $\frac{1}{2}$ in. reach
Sparking plug gap .. .. .	.019 to .021 in. (.48 to .53 mm.)
Contact breaker gap .. .. .	.014 to .016 in. (.36 to .41 mm.)
Rear axle ratio .. .. .	4.3 : 1
Overall gear ratios : First .. .. .	15.652 : 1
Second .. .. .	9.520 : 1
Third .. .. .	5.908 : 1
Fourth .. .. .	4.3 : 1
Reverse .. .. .	20.468 : 1
Tyre size .. .. .	5.60—15
Tyre pressures :	
Normal .. .. .	Front : 17 lb./sq. in. (1.2 kg./cm. <sup>2</sup> ) Rear : 20 lb./sq. in. (1.4 kg./cm. <sup>2</sup> )
Full load or fast driving .. .. .	Front: 21 lb./sq. in. (1.48 kg./cm. <sup>2</sup> ) Rear : 24 lb./sq. in. (1.69 kg./cm. <sup>2</sup> )
Competition work, sustained high-speed driving	(Front: 23 lb./sq. in. (1.62 kg./cm. <sup>2</sup> ) Rear: 26 lb./sq. in. (1.83 kg./cm. <sup>2</sup> )
Dimensions :	
	<i>Disc wheels</i> <i>Wire wheels</i>
Track—Front .. .. .	3 ft. 11 $\frac{1}{2}$ in. (1.206 m.)    3 ft. 11 $\frac{7}{8}$ in. (1.216 m.)
Rear .. .. .	4 ft. 0 $\frac{1}{2}$ in. (1.238 m.)    4 ft. 0 $\frac{1}{2}$ in. (1.238 m.)
Turning circle .. .. .	28 ft. 0 in. (8.53 m.)
Toe-in .. .. .	Nil
Wheelbase .. .. .	7 ft. 10 in. (2.388 m.)
Length (overall) .. .. .	13 ft. 0 in. (3.96 m.)
Width (overall) .. .. .	4 ft. 9 $\frac{1}{4}$ in. (1.45 m.)
Height (overall) .. .. .	4 ft. 2 in. (1.27 m.)
Ground clearance .. .. .	6 in. (15.24 cm.)
Unladen weight (ready for road) .. .. .	17 cwt. 3 qrs. (902 kg.)
Capacities :	
Fuel tank .. .. .	10 gal. (45.4 litres, 12 U.S. gal.)
Cooling system .. .. .	10 pints (5.67 litres, 12 U.S. pints)
Engine sump (including filter) .. .. .	8 pints (4.54 litres, 9 $\frac{1}{2}$ U.S. pints)
Gearbox .. .. .	4 pints (2.27 litres, 4 $\frac{3}{4}$ U.S. pints)
Rear axle .. .. .	2 $\frac{3}{4}$ pints (1.56 litres, 3 $\frac{1}{4}$ U.S. pints)

Lamp bulbs—see page 39

NOTE.—References to right or left hand in this Handbook are made when viewing the car from the rear.

## CONTROLS

## INSTRUMENTS

## SWITCHES

## OPTIONAL EQUIPMENT

# CONTROLS

## DOOR LOCKS (Coupé only)

The door on the driver's side of both left- and right-hand-drive two-seater coupés is locked from the outside of the car, using the ignition key. The passenger door is locked by lifting the interior door handle to its uppermost position. Push the handle downwards to unlock the door.

## HAND BRAKE

The hand brake lever is located alongside the gearbox cover and operates the rear wheel brakes only.

To operate, pull up the lever and press the knob in the end with the thumb to lock the lever in position. To release the brakes, pull upwards on the lever to release the lock automatically and then push downwards.

Always apply the hand brake when parking.

## BRAKE PEDAL

The centre pedal operates the hydraulic brakes on all four wheels and will also operate the twin stop warning lamps when the ignition is switched on.

## CLUTCH PEDAL

The left-hand pedal operates the hydraulic clutch release. Do not allow the foot to rest on the clutch pedal while driving as this will cause excessive wear of the operating mechanism.

## GEAR LEVER

The four forward gears and the reverse gear are engaged by moving the lever to the positions indicated in the illustration inset opposite.

To engage the reverse gear move the lever to the left of the neutral position until resistance is felt, apply side pressure to the lever to overcome the resistance and then pull it backwards to engage the gear.

Synchromesh engagement is provided on second, third and fourth gears.

Ensure that the gear lever is in the neutral position before attempting to start the engine.

## STEERING COLUMN ADJUSTMENT

A steering column which is adjustable for length is available as an optional fitting. This enables the steering wheel to be placed in the most comfortable driving position after slackening a clamp bolt below the wheel hub.

Always retighten the nut securely after adjustment. See the inset in the illustration opposite.

## HEADLAMP BEAM DIP SWITCH

This is situated to the left of the clutch pedal and is foot-operated. The switch will dip the headlamp beams on one depression and raise them on the next.

To give the driver clear indication when the headlamp beams may dazzle approaching drivers a warning light in the speedometer dial glows when the headlamp beams are in the raised position.

# CONTROLS

## BONNET LOCK RELEASE

The bonnet is hinged at the rear and the lock is released by pulling on the ring below the instrument panel on the extreme left-hand side of the car.

The bonnet is still held by the safety catch, which must be released before the bonnet can be raised. (See page 16.)

To re-lock the bonnet in the fully closed position after opening, press downwards on the front of the bonnet until the lock is heard to engage.

## SEAT ADJUSTMENT

A lever is provided at the front of each seat and this must be pressed outwards to release the catches and allow the seat to slide.

The seat will lock in the desired position as the lever is released.

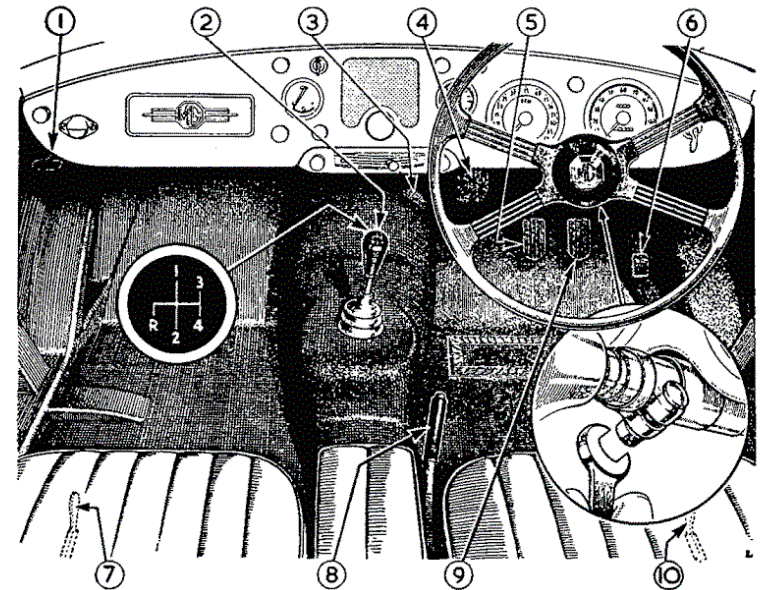

1. Bonnet release.

2. Gear lever.

3. Gearbox oil filler plug.

4. Headlamp dip switch.

5. Clutch pedal.

6. Accelerator.

7. Seat lock.

8. Hand brake lever.

9. Foot brake.

10. Seat lock.

# INSTRUMENTS AND SWITCHES

## SPEEDOMETER

In addition to indicating the speed of the car, the speedometer records the trip and total distances. The trip recorder enables the distance of a particular journey to be recorded and is reset to zero by pushing upwards the knob below the instrument and turning it anti-clockwise until the figures read zero.

## MAIN BEAM WARNING LIGHT

The warning light at the bottom of the speedometer dial glows red when the headlamp main beams are in use, as a reminder to dip the beams when approaching other traffic.

## ENGINE REVOLUTION INDICATOR

The speed of the engine is indicated by this dial, which is calibrated in hundreds of revolutions per minute. Normal use of the engine will not require speeds over 5,000 r.p.m. and great care must be taken if the needle does approach the amber sector of the dial, which commences at 5,500 r.p.m. Under favourable conditions the needle may be allowed to enter the amber sector but under no circumstances must it enter the red sector.

## IGNITION WARNING LIGHT

The warning light at the bottom of the revolution indicator dial glows red when the ignition is switched on and will go out again when the engine is started and its speed is increased sufficiently for the dynamo to charge the battery. Should the light glow at all engine speeds, the dynamo is not charging the battery and the wiring circuit and dynamo drive belt should be examined immediately.

Do not leave the ignition switched on for more than a few moments while the engine is stationary.

## OIL PRESSURE GAUGE

The pressure of the oil in the engine lubricating system as shown on the gauge should be between 30 lb./sq. in. and 80 lb./sq. in. (2.1 kg./cm.<sup>2</sup> and 5.6 kg./cm.<sup>2</sup>) under normal running conditions. Approximately 10 lb./sq. in. (·7 kg./cm.<sup>2</sup>) should be shown when the engine is idling.

## WATER TEMPERATURE GAUGE

The temperature of the cooling water leaving the cylinder head is indicated by this gauge and should be approximately 160 to 190° F. when the engine is running normally. If the normal running temperature is greatly exceeded the cause must be traced and rectified immediately.

## HORN-PUSH

This is the black button below the grille in the centre of the panel.

# INSTRUMENTS AND SWITCHES

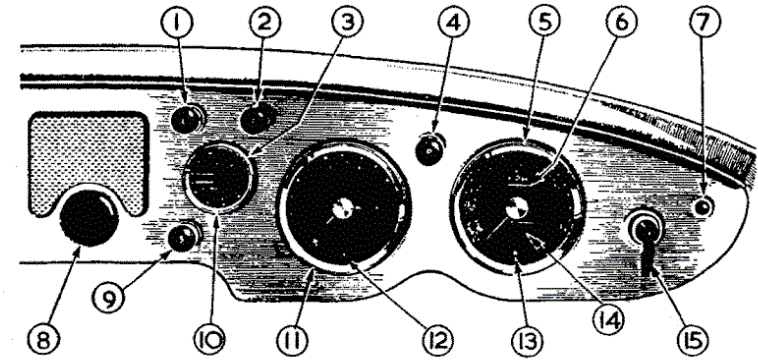

- |                                  |                                  |
|----------------------------------|----------------------------------|
| 1. Headlamp and sidelamp switch. | 9. Starter switch.               |
| 2. Fog lamp switch.              | 10. Water temperature gauge.     |
| 3. Oil gauge.                    | 11. Revolution indicator.        |
| 4. Panel light switch.           | 12. Ignition warning light.      |
| 5. Speedometer.                  | 13. Headlamp beam warning light. |
| 6. Trip mileage.                 | 14. Total mileage.               |
| 7. Flasher warning light.        | 15. Direction indicator switch.  |
| 8. Horn button.                  |                                  |

## STARTER SWITCH

Pull out the knob marked 'S' to operate the starter motor. The switch must be pulled out smartly and pushed in immediately the engine starts. If the engine does not start at once, allow it to come to rest before using the switch again.

## LAMP SWITCH

To switch on the sidelamps, tail lamps, and number-plate illumination lamp pull out the knob marked 'L'. Turn the knob clockwise and pull out again to switch on the headlamps. See 'HEADLAMP BEAM DIP SWITCH' on page 6.

## FOG LAMP SWITCH

A fog lamp is not fitted as standard equipment, but the switch marked 'F' on the instrument panel is connected to the battery and is ready for use when a fog lamp is connected to it. Pull out the knob to switch on the fog lamp.

## PANEL LAMP SWITCH

To illuminate the instruments turn the control knob 'P' clockwise. The first movement of the knob will switch on the lamps and further turning to the right will dim the lamps. The panel lamps will operate only when the sidelamps also are switched on.

## INSTRUMENTS AND SWITCHES

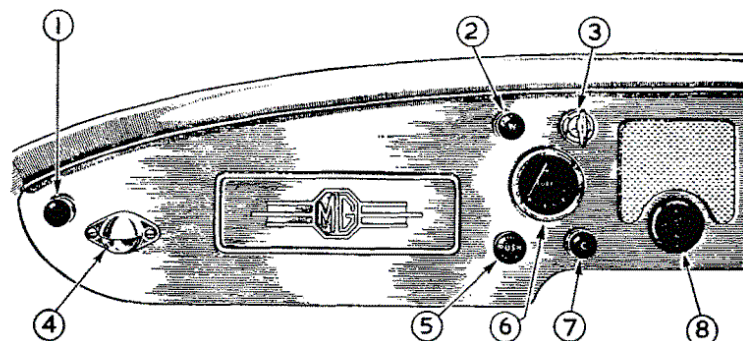

- |                              |                               |
|------------------------------|-------------------------------|
| 1. Map-reading light switch. | 5. Windshield washer control. |
| 2. Windshield wiper switch.  | 6. Fuel gauge.                |
| 3. Ignition switch.          | 7. Choke control.             |
| 4. Map-reading light.        | 8. Horn button.               |

### DIRECTION INDICATOR SWITCH

The lever-type switch on the outer edge of the panel controls the flashing indicator unit. The unit will operate only while the ignition is switched on and flashes the sidelamp and tail lamp on the side of the car to which the switch lever is moved until it is automatically switched off.

While the flashing unit is switched on the warning light next to the switch will show green.

### FUEL GAUGE

This operates only when the ignition is switched on and indicates the quantity of fuel in the tank.

### CHOKE OR MIXTURE CONTROL

To enrich the mixture and assist starting when the engine is cold, pull out the knob marked 'C' and lock it in position by turning it anti-clockwise.

Turn the knob clockwise and push it inwards to the normal running position as soon as the engine is warm enough to run without the rich mixture.

Never allow the engine to run for any length of time with the knob pulled out.

### IGNITION SWITCH

Turn the ignition switch key clockwise to switch on the ignition. Do not leave it switched on when the engine is not running, except for very short periods.

The fuel pump and gauge are brought into action by this switch, which is also the master switch for the windshield wipers and direction indicators. Without the removable key the engine cannot be started.

## INSTRUMENTS AND SWITCHES

### WINDSHIELD WIPER SWITCH

Pull out the control 'W' to set the wiper blades in motion. Push in the knob to switch off the motor and park the blades.

The windshield wipers are self-parking and operate only when the ignition is switched on.

### MAP-READING LAMP

The map-reading lamp is controlled by the adjacent knob, which must be pulled out to switch on the light. The lamp will only operate while the sidelamps are switched on.

## OPTIONAL EQUIPMENT

### HARD-TOP

The hard-top can be fitted either with or without the hood removed from the vehicle. If the hood is to be kept in the car, then it should be stowed away neatly prior to fitting the hard-top. The plated retaining brackets at the rear edge of the hard-top canopy should first be engaged with the anchor brackets (1) on the tonneau panel above the boot lid. Next, the hook-type side clips should be fitted over the hood frame pivot pins (2) and the knurled knobs screwed up lightly. Attach the front of the canopy by the method used

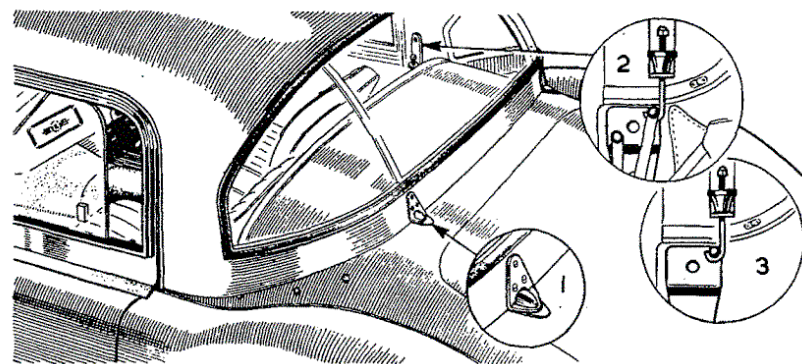

to secure the folding hood, and after tightening the winged bolts the knurled knob on each side clip should also be fully tightened.

If the hood is not required it can be removed completely and special attachment brackets (available from an M.G. Distributor or Dealer) fitted in place of the hood frame pivot plates (3). Sidescreens of the sliding pattern should be used with the hard-top.

# OPTIONAL EQUIPMENT

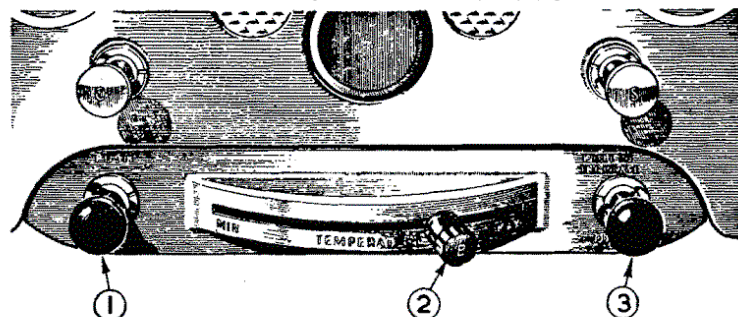

1. Air control. 2. Blower switch and temperature control. 3. Demist control.

## HEATING AND DEMISTING EQUIPMENT

When the 2.75-kw. heating and demisting unit is fitted, fresh air is ducted from the radiator grille to the heating element and blower motor mounted below the bonnet. Water from the engine cooling system is used to heat the element.

Warmed air issues from the toeboard or the windshield demisting vents according to the position of the controls mounted below the instrument panel. In warm weather the controls may be set to provide unheated fresh air for ventilation.

**Air.** The left-hand knob controls the air supply. When the knob is pushed in the air duct is open and air at atmospheric temperature will enter the car when it is in motion and will issue from the toeboard or demisting vents.

**Air blower.** Pull out knob marked 'B' on the temperature control lever to switch on the blower motor, if the ignition is switched on also, and this will increase the flow of air into the car and may be used to give a supply of air when the car is stationary or travelling at low speed.

If the blower motor is switched off and the air control knob pulled outwards to close the air duct, fresh air cannot enter the car from the toeboard or windshield vents.

**Demist.** The right-hand knob on the heater unit control panel operates a shutter in the panel above the gearbox cover. When the control is pushed into the normal position the shutter is open and most of the air from the unit will enter the car at the toeboard while some will issue from the vents below the windshield. As the knob is pulled out the shutter closes and more air is delivered to the demisting vents, giving the maximum supply of air to the windshield. This is the demist position of the control and also the windshield defrost position when the heater is operating and the blower is switched on.

**Temperature.** The temperature lever operates the water valve on the engine. When the lever is in the left-hand position the hot water supply is cut off and air entering the car through the unit will not be heated. As the lever is moved to the right the water supply is increased until the maximum temperature is obtained.

# OPTIONAL EQUIPMENT

As a general guide, here are some of the more frequently required positions :  
**No additional ventilation or heating.** Pull out the air control, push the temperature control to the left.

- Hot weather.** Push in the air and demist controls. Move the temperature control to the left. To increase the supply of air switch on the blower motor.
- Warm weather.** Set the controls as for hot weather. To increase the supply of air switch on the blower motor. To prevent mist forming on the windshield pull out the demist control partially.
- Cold weather.** Place the air control in its normal position. Place the temperature lever according to the degree of heating required. Switch on the blower to increase the air supply (if demisting is required pull out the demist control).
- Severe cold.** Move the temperature control to the right for maximum heating and pull out the demist control fully to give a maximum supply of hot air to the windshield. Switch on the blower motor to increase air flow.

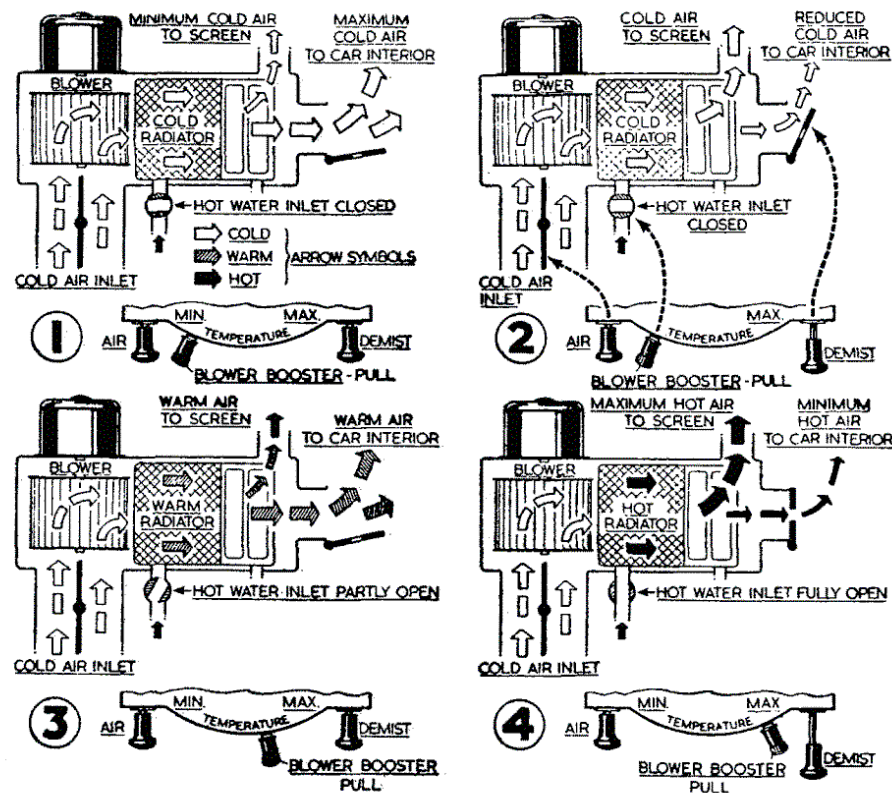



## OPTIONAL EQUIPMENT

### WINDSHIELD WASHER

The washing equipment supplied as an optional fitting is operated by pumping the knob on the instrument panel. As the knob moves towards the panel a jet of cleaning fluid is ejected onto the windshield from nozzles on the scuttle.

Set the windshield wipers in motion before operating the cleaning jets.

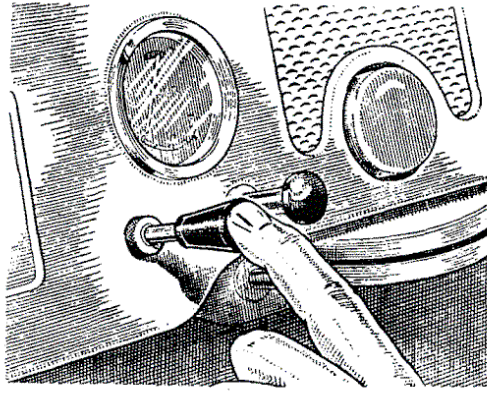

### WINDSHIELD WASHER FLUID

Fluid for the windshield is stored in an unbreakable bottle clipped to the engine bulkhead on the opposite side to the brake and clutch master cylinder. When refilling with fluid, unscrew the cap from the bottle and lift the bottle from its clip.

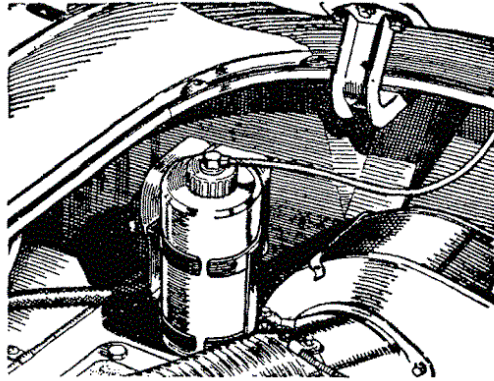

### The following items of equipment are available as optional fittings:

- |  |   |
|--|---|
| Wire wheels.   | H.M.V. car radio (provision has been made for easy installation). |
| White-walled tyres.                                    | Windshield washer.  |
| 5-90—15 speed tyres.                                   | Detachable hard-top.  |
| Rim embellishers.                                      | Sliding windows.  |
| Alternative axle ratio (4.55 : 1).                     | Competition windshield assembly.                                  |
| Adjustable steering column (see page 6).               | Luggage carrier.  |
| Tonneau cover.   | Wing driving mirror.  |
| Radiator blind (see page 32).                          | Cold air ventilation kit.   |
| Heating and demisting equipment (see pages 12 and 13). | Ashtray.  |
| Twin horns.  | Badge bar.  |
| Fog lamp (see page 9).                                 | Ace wheel discs.  |
| Cigar lighter.   |   |

## PREPARING FOR THE ROAD

## PREPARING FOR THE ROAD

### FILLING THE FUEL TANK

The quantity of fuel in the tank is indicated on the instrument panel and the filler cap is at the rear of the car on the right-hand side.

Lift the small lever on the cap to release and raise the cap. Press the cap downwards to close it.

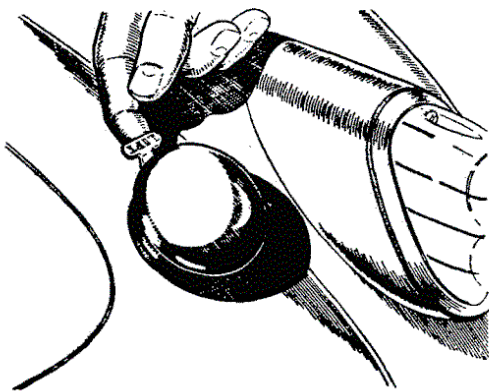

### BONNET SAFETY CATCH

After releasing the bonnet lock from inside the car (page 7) push back the safety catch and raise the bonnet. Release the prop from the under side of the lid and place its end in the hole provided in the deflector above the fan blades.

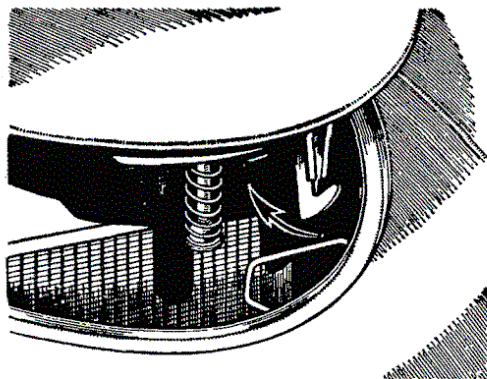

### FILLING THE RADIATOR

The radiator should be filled until approximately 1 in. (25 mm.) of water is visible in the filler neck.

Unscrew the filler cap slowly if it is being removed while the engine is hot. The filler cap is retained by a bayonet catch with a graduated cam which permits release of internal pressure prior to removal. A lobe on the end of the cam guards against accidental release of the cap before the internal pressure is relieved. Protect your hand against escaping steam.

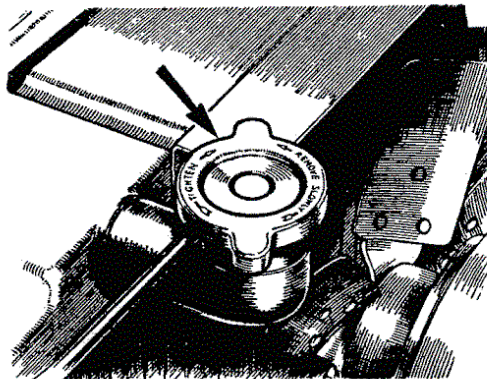

## PREPARING FOR THE ROAD

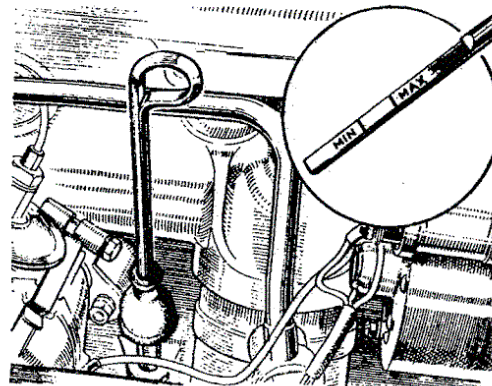

### CHECKING THE ENGINE OIL

Check the supply of oil in the sump by withdrawing the dipstick on the right-hand side of the cylinder block. Wipe the lower portion of the rod, reinsert it, and withdraw it again. Oil will cling to the rod and show the actual quantity present in the sump. The normal oil level is indicated by the 'MAX' mark on the dipstick and should not be allowed to fall very far below this mark.

The oil level should be checked daily.

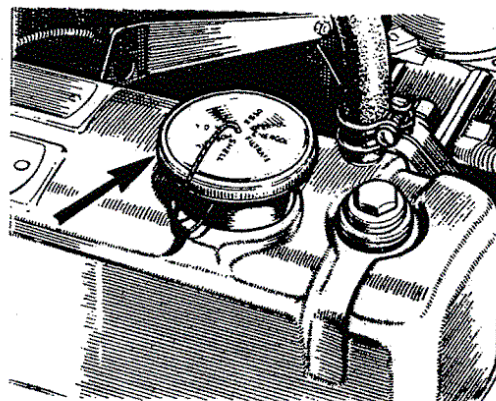

### FILLING UP WITH ENGINE OIL

The filler cap is on top of the engine valve cover and is released by turning anti-clockwise.

When replacing the cap turn it clockwise to lock it in position.

Clean, fresh oil is essential and a list of the recommended lubricants is given at the end of this Handbook.

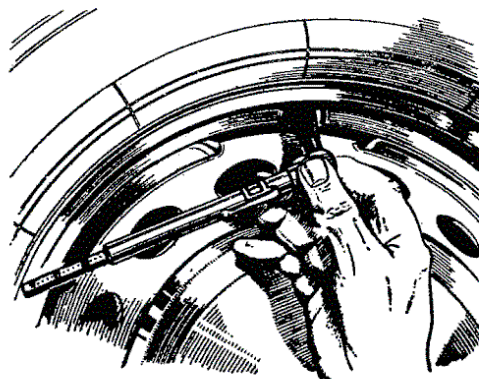

### CHECKING TYRE PRESSURES

The tyre pressures should be checked and, if necessary, adjusted weekly. Gauges for testing tyre pressures can be bought from all reputable motor dealers.

The correct tyre pressures are given on page 4.

# PREPARING FOR THE ROAD

---

## STARTING UP

See that the gear lever is in the neutral position and that the hand brake is on. Pull out the mixture control knob and turn it to lock it in the open position. Use of this control is unnecessary when the engine is hot, and it need only be pulled out part of the way if the engine is warm.

Switch on the ignition and pull the starter switch knob smartly. The engine should revolve and start. Release the knob immediately the engine fires.

Gradually return the mixture control to the normal position as soon as the warming engine will allow.

## WARMING UP

It is extremely bad practice to allow the engine to warm up from cold by letting it idle slowly. The correct procedure is to let the engine turn over fairly fast (approximately 1,000 r.p.m.), so that it attains its correct working temperature **AS QUICKLY AS POSSIBLE.**

## RUNNING IN

It is a great mistake to run a new car too fast. For the first 200 miles (320 km.) the following speeds should not be exceeded :

- 45 miles (72 km.) per hour (2,700 r.p.m.) in top gear.
- 30 miles (48 km.) per hour (2,500 r.p.m.) in third gear.
- 20 miles (32 km.) per hour (2,600 r.p.m.) in second gear.
- 10 miles (16 km.) per hour (2,100 r.p.m.) in first gear.

The engine speeds should then only be increased gradually and progressively until at least 1,000 miles (1600 km.) have been covered.

## GOOD DRIVING

Always change down early when encountering a gradient. It is bad practice to allow an engine to labour on a hill and the engine is unable to pick up properly on the lower gear if changing is left too late.

Always take your foot off the clutch pedal when you are not actually operating the clutch. This saves clutch wear.

It is advisable to engage a lower gear when descending a steep hill and leave the clutch engaged to obtain the advantage of the braking action of the engine. Don't coast with the clutch pedal depressed.

Always apply the brakes gently and progressively. Violent braking throws unnecessary strain on the car and tyres, causes skidding and is dangerous. A good and careful driver anticipates the need for braking. Never attempt to engage reverse gear when the car is moving forwards or a forward gear when the car is moving backwards.

# LUGGAGE AND TOOLS

## LUGGAGE AND TOOLS

---

### OPENING THE LUGGAGE BOOT

Tip forward the left-hand seat and pull the ring at the rear of the hood stowage compartment on the left-hand side.

Raise the boot lid and support it with the prop clipped to the under side.

To close the lid, stow the prop and press down until the lock is heard to engage.

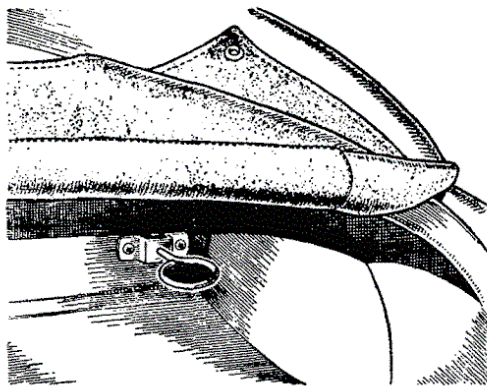

### STARTING HANDLE AND TOOL KIT

The starting handle is located in spring clips above the spare wheel in the luggage compartment and the jack and tool kit are housed in a roll strapped above the spare wheel.

When using the starting handle keep the thumb on the same side of the handle as the palm of the hand for safety in case of a backfire.

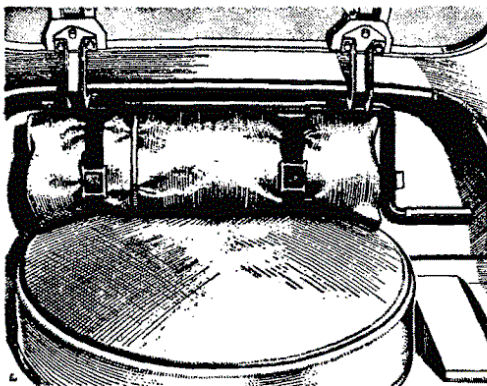

## WHEELS AND TYRES

## WHEELS AND TYRES

### SPARE WHEEL

The spare wheel is housed in the luggage compartment and is clamped in position beneath the cover. Remember that the spare wheel tyre should be maintained at the normal running pressure of the rear tyres. For tyre pressures see page 4.

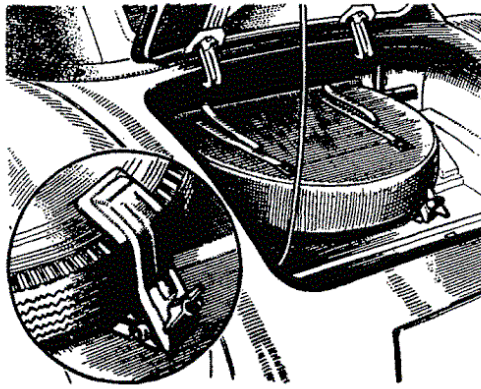

### JACKING UP (FRONT)

The screw-type jack should be placed under the lower wishbones, with its pad engaging the depression between the spring seating and the lower link.

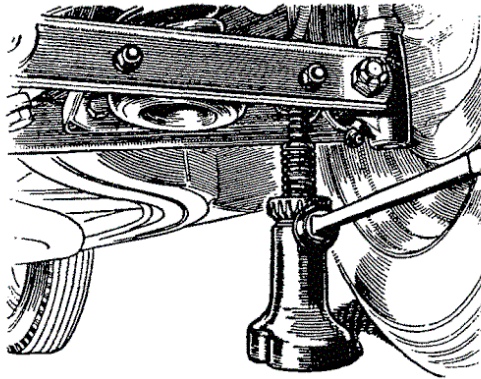

### JACKING UP (REAR)

The screw-type jack should be placed under the rear spring, close to the axle, when lifting the rear of the car.

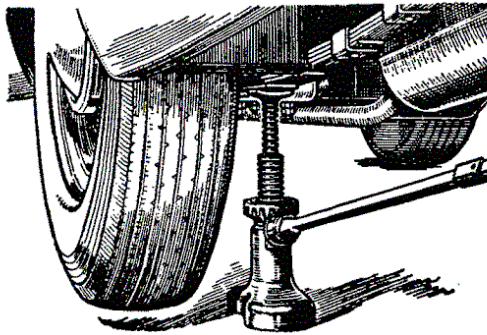

## WHEELS AND TYRES



### REMOVING THE WHEEL DISCS

Remove the wheel disc by inserting the flattened end of the wheel nut spanner in the recess provided in the road wheel and levering off the hub cover, using a sideways motion of the spanner and not a radial one. A radial movement of the spanner will open out the rim of the disc. To refit the hub disc, the rim should be placed over two of the buttons on the wheel centre and the outer face given a sharp blow with the fist over the third button.

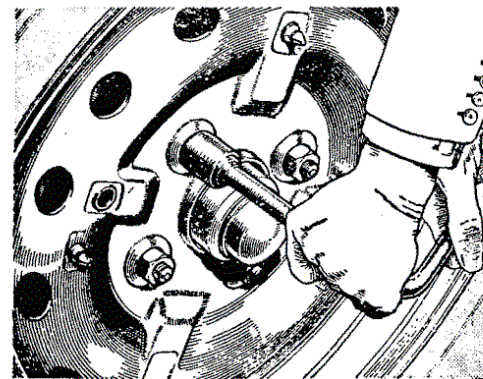

### REMOVING PRESSED WHEELS

Slacken the four nuts securing the road wheels to the hub; turn clockwise to tighten and anti-clockwise to loosen. Raise the car to lift the wheel clear of the ground and remove the nuts. Withdraw the road wheel from the hub, taking care not to lose the brake adjuster hole seal. When replacing the road wheel ensure that the correct hole in the wheel is in line with the brake-drum hole and that the securing nuts are fitted with the taper side towards the wheel.

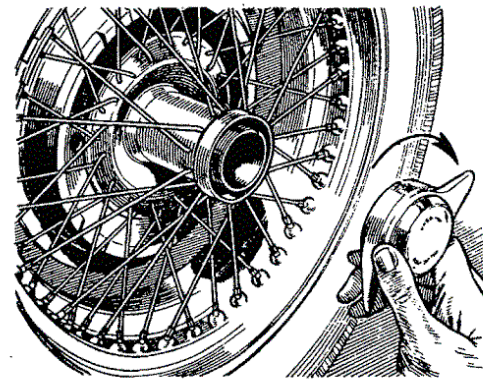

### REMOVING WIRE WHEELS

Use the copper mallet provided in the tool kit to slacken the winged hub nut used to secure the wire wheel to its splined shaft. The hub nuts on the left-hand side of the car have right-hand threads (turn anti-clockwise to unscrew) and the nuts on the right-hand side of the car have left-hand threads (turn clockwise to unscrew). A right-hand wheel is shown in the illustration.

# WHEELS AND TYRES

## TYRE REMOVAL

Inextensible wires are incorporated in the edges of tyres. Do not attempt to stretch the edges of the tyre cover over the rim. Force is entirely unnecessary and dangerous, as it merely tends to damage the cover edges. Fitting or removing will be quite easy if the wire edges are carefully adjusted into the rim base. If the cover edge fits tightly on the rim seating it should be freed by using the tyre levers as indicated.

Remove all valve parts to completely deflate the tyre and push both cover edges into the base of the rim at the point diametrically opposite to the valve, then lever the cover edge near the valve over the rim edge (see illustration below).

This permits the tyre valve to be pushed through the hole in the rim and the inner tube to be withdrawn for attention when required.

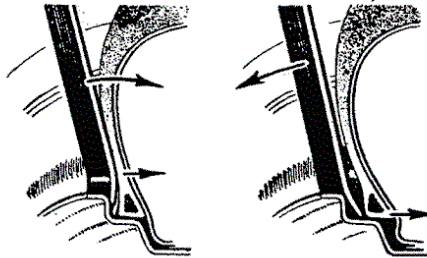

1. Insert lever between bead and rim with curved end against tyre. Press lever towards tyre.
2. Insert second lever in space between bead and rim, with curved end outwards, and pull lever away from tyre. Repeat at intervals round tyre until bead is free. Several circuits of tyre may be necessary.

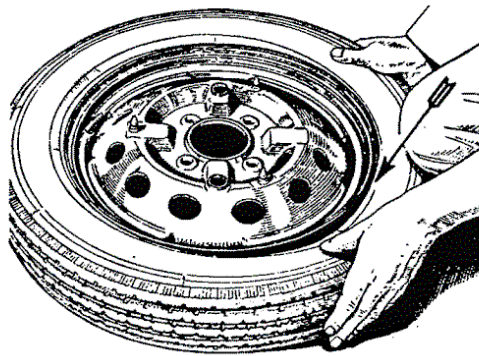

## TYRE REPLACEMENT

A similar technique has to be employed when replacing the tyre, first fitting the tyre into the rim at a point opposite to the valve, and finishing the fitting in the region of the valve, keeping the beaded edge in the well-base of the rim.

## REPAIRING TUBES

Have punctures or injuries vulcanized. Ordinary patches should only be used for emergencies. Vulcanizing is absolutely essential in the case of tubes manufactured from synthetic rubber.

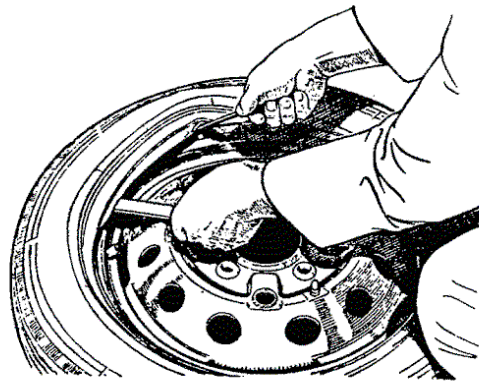

# WHEELS AND TYRES

## TYRE VALVES

The airtightness of the valve depends upon the proper functioning of its interior. It may be tested for airtightness by rotating the wheel until the valve is at the top and inserting it in an eggcup full of water. If bubbles appear the interior is faulty and should be replaced by a new one.

## VALVE INTERIORS

It is advisable always to have spare interiors handy, and these are procurable suitably packed in small metal containers. A small extracting and fitting tool is supplied in the tool kit.

Always make sure that valve interiors are screwed well home on replacement.

## VALVE CAPS

The valve caps should be kept firmly tightened to prevent dust and water entering and damaging the valve seats. The caps also act as an additional air seal.

When they are removed for tyre inflation or removal they should always be placed in a clean place.

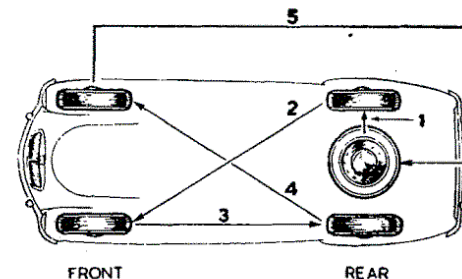
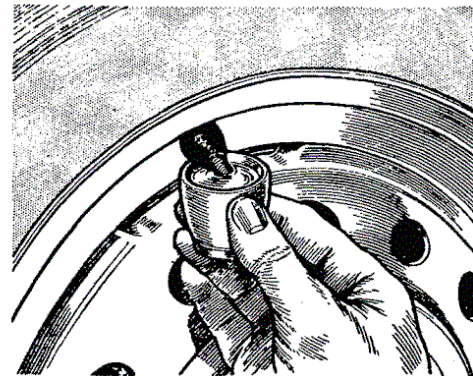
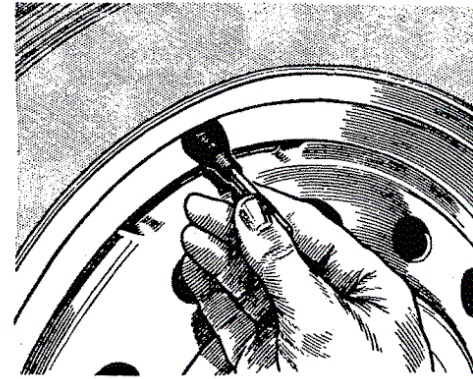

## CARE OF TYRES

Every 3,000 miles (4800 km.) the running position of the tyres should be changed and the spare should come into use. This will equalize the tyre wear of the front and rear wheels and prolong the life of the tyres.

Inspect the tyres frequently and remove any pieces of flint, stone or glass which have become embedded in the covers.

See front wheel alignment, page 59.

## WHEELS AND TYRES

---

### CARE OF WIRE WHEELS

Wire wheels will require periodic checking to see that no spokes have worked loose or are losing their tension.

This can be done by drawing a light spanner or similar metal object across the spokes, which should emit a clear ringing note. If any spokes are slack the note will be dull or flat by comparison.

Any small amount of individual slackness may be taken up by adjusting the spoke nipple with a spanner, but great care must be taken to ensure the general tension of the wheel is not upset by overtightening any of the spokes as this will cause other spokes to break and the wheel to run out of truth.

If a spoke is replaced and it is found that the spoke end protrudes through the nipple body it must be filed off carefully to prevent any damage to the tube.

Tyres should be removed periodically so that the wheel rim can be examined for corrosion.

Any signs of rust must be removed by polishing with emery-paper and the area afterwards protected with paint.

When a general overhaul of wheels becomes necessary, they should be sent to a wheel specialist for repair.

---

## SIDESCREENS AND HOOD

## CLEANING THE CAR

---

## SIDESCREENS AND HOOD

### SIDESCREENS

The sidescreens are attached to the doors by means of a pin and socket at the rear, and a bracket at the front which is clamped in position by a pin and wing nut.

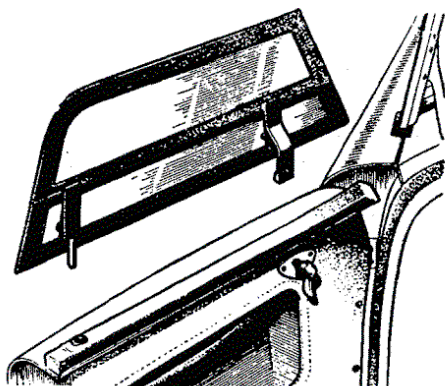

### SIDESCREEN STOWAGE

The sidescreens are stowed in a container behind the seats and each should be placed in a separate pocket with the cranked bracket at opposite ends and facing the rear of the car.

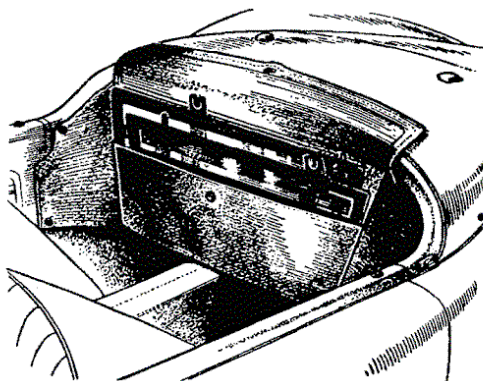

### RELEASING THE HOOD

The hood is secured to the top of the windshield by two wing bolts which must be slackened to release the hood. When the hood is lowered fold it correctly to prevent damage.

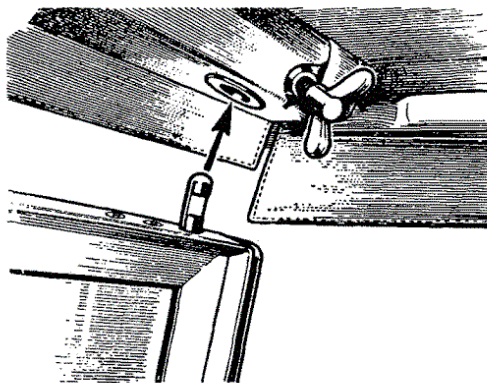

## SIDESCREENS AND HOOD

### FOLDING THE HOOD

Never fold the hood when it is wet or damp—wait until it is dry.

- (1) Release the hood from the pillars at the top of the windshield.
- (2) Release the rear of the hood from the three buttons and the turn-buckle at each side. Pull on the centre knob to release each button.
- (3) Raise the front of the hood slightly to release the tension in the canvas, and pull the bottom of the hood to the rear to release it from the two anchor brackets above the luggage boot lid.
- (4) Tip the seats forward, unfasten the sidescreen container and turn it over onto the tonneau panel.
- (5) Leave the rear window panel suspended over the body panel and collapse the hood into the stowage compartment, pulling the material clear of the

*(continued on page 30)*

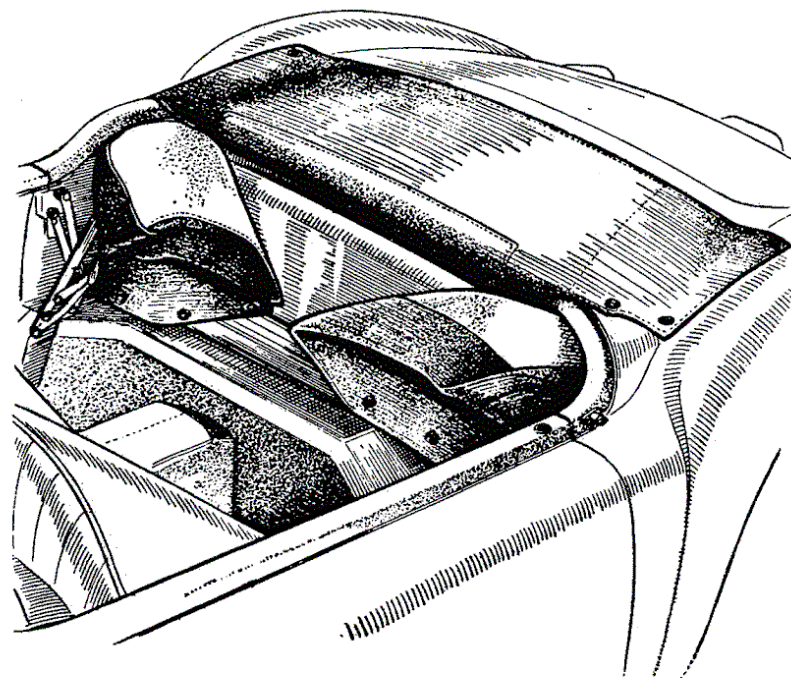



## CLEANING THE CAR

---

hood irons and folding it over the front rail. Fold the rear window forwards over the hood, pulling out the spare material at each side and folding it neatly over the front of the window.

- (6) Push the folded hood well into the stowage compartment and bring the sidescreen container forward to cover the hood.
- (7) Remove the sidescreens and stow them in the container pockets with the cranked bracket of each screen at opposite ends and facing the rear.
- (8) Secure the sidescreen container over the folded hood with the six buttons.

### CLEANING THE CAR

**Bodywork.** The car should be washed and dried thoroughly before applying polish. The use of a good non-abrasive polish is essential.

Grease and tar spots must be carefully removed with a wadding pad dipped in petrol (gasoline). Chromium plating should be washed frequently with soap and warm water only. Metal polishes, or abrasives of any sort, must not be used.

**Windshield.** Methylated spirits (denatured alcohol) should be used to remove tar spots and other stains from the windshield. It has been found that the use of some silicon- and wax-based polishes for this purpose can be detrimental to the wiper blades.

**Upholstery.** The upholstery should be cleaned at regular intervals by wiping it with a damp cloth and polishing it with a clean soft cloth when it is dry. The use of polish is quite unnecessary.

**Hood.** When necessary the hood cloth may be cleaned with water applied with a brush without impairing its waterproof qualities.

Soaps and mild detergents may be used, provided the hood surfaces are well washed with water afterwards.

---

## COLD WEATHER PRECAUTIONS

# COLD WEATHER PRECAUTIONS

---

## COLD WEATHER PRECAUTIONS

If the car is not stored in a warmed building, steps must be taken to prevent the cooling water from freezing during frosty weather. Water, upon freezing, expands, with the result that there is a very considerable risk of bursting either the radiator or the cylinder block by the pressure generated. As a precautionary measure when frost is anticipated, the water should be drawn from the radiator and engine (see page 33) before the car is stored for the night, or, better still, an anti-freeze solution may be used in the radiator. We recommend owners to use Bluecol, Shell Snowflake, Esso Anti-freeze, or Filtrate Nevafreeze non-erosive anti-freeze in order to protect the cooling system during frosty weather and reduce corrosion to a minimum.

## IMPORTANT

Never use a muff on the radiator grille to protect the cooling system in cold weather as this would seal the carburettor and heater unit air supply. The radiator must be protected by a blind such as the type available as an optional extra fitting.

## WARNING

As the cooling system is sealed, relatively high temperatures are developed in the radiator upper tank. For this reason anti-freeze solutions having an alcohol base are unsuitable owing to their high evaporation rate producing rapid loss of coolant and a consequent interruption of the circulation of coolant.

Only anti-freeze of the ethylene glycol or glycerine type is suitable for use in the cooling system.

The correct quantities of anti-freeze for different degrees of frost resistance are :

15° frost	..	..	..	1 pint (.57 litre, 1.2 U.S. pints)
25° frost	..	..	..	1½ pints (.85 litre, 1.8 U.S. pints)
35° frost	..	..	..	2½ pints (1.42 litres, 3 U.S. pints)

First decide what degree of frost protection is required before adding the anti-freeze to the radiator. If temperatures below 0° F. (-18° C.) are likely, solutions of 25 per cent, or more must be employed. Consult your local Dealer for the correct proportions.

Before introducing anti-freeze mixture to the radiator it is advisable to clean out the cooling system thoroughly by swilling out the passages with a hose inserted in the filler cap, keeping the drain taps open. Only top up when the cooling system is at its normal running temperature, in order to avoid losing anti-freeze due to expansion.

Make sure that the cooling system is watertight and examine all joints, replacing any defective rubber hose with new.

The capacity of the cooling system is 10 pints (5.7 litres, 12 U.S. pints).

# LUBRICATION CHART

# 'MGA' LUBRICATION CHART

## MULTIGRADE MOTOR OILS

In addition to the lubricants recommended in this Handbook we also approve the use of the multigrade motor oils produced by the oil companies shown in our publications for all climatic temperatures unless the engine is in poor mechanical condition.

## DAILY

- (1) ENGINE. Check oil level with dipstick. Replenish if necessary with new oil (Ref. A).

## EVERY 1,000 MILES (1600 Km.)

- (2) GEARBOX. Check oil level with dipstick. Replenish if necessary with new oil (Ref. A).
- (3) REAR AXLE. Replenish oil to level of filler plug hole. Use new oil (Ref. B).
- (4) STEERING. Give three or four strokes with grease gun filled with grease (Ref. D) to nipples on steering joints.
- (5) PROPELLER SHAFT. Give nipples three or four strokes with gun filled with grease (Ref. D).
- (6) HAND BRAKE. Give cable nipple three or four strokes with gun filled with grease (Ref. E).
- (7) CARBURETTOR. Remove cap from each suction chamber and insert small quantity of oil (Ref. F).
- (8) MASTER CYLINDER. Inspect fluid level in supply chamber, and refill if necessary with Lockheed Genuine Brake Fluid.

## EVERY 3,000 MILES (4800 Km.)

- (9) ENGINE. Drain used oil from sump. Refill to 'MAX' mark on dipstick with new oil (Ref. A).
- (10) OIL FILTER. Wash element and bowl in fuel and refit or fit new element.
- (11) DISTRIBUTOR. Withdraw rotating arm and add a few drops of oil (Ref. F) to spindle and also to advance mechanism. Smear cam and contact pivot with grease or oil.
- (12) DYNAMO. Add two drops of oil (Ref. F) to oil hole in rear end bearing plate.

## EVERY 6,000 MILES (9600 Km.)

- (13) OIL FILTER. Renew element and wash bowl in fuel.
- (14) GEARBOX. Drain used oil. Refill to 'HIGH' mark on dipstick with new oil (Ref. A).
- (15) REAR AXLE. Drain used oil and refill to level of filler plug hole with new oil (Ref. B).
- (16) WATER PUMP. Remove plug and add a small quantity of S.A.E.140 Oil.
- (17) FRONT HUBS. Remove front wheel hub discs and grease caps. Fill caps with grease (Ref. C) and replace.

## EVERY 12,000 MILES (19200 Km.)

- (18) STEERING. Give up to 10 strokes to nipple on steering gearbox and two strokes only to pinion shaft nipple with gun filled with oil (Ref. B).

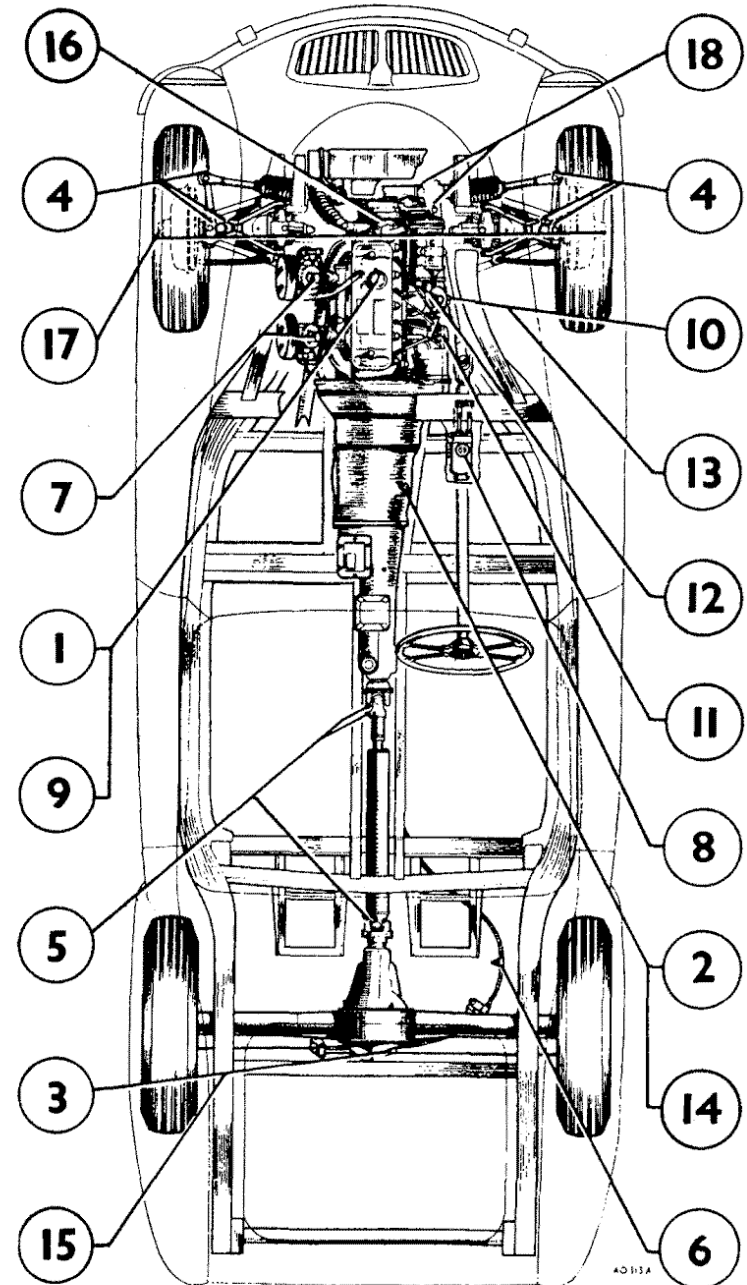

FOR COMPLETE SUMMARY OF MAINTENANCE ATTENTION REFER TO PAGES 48-9

# COLD WEATHER PRECAUTIONS

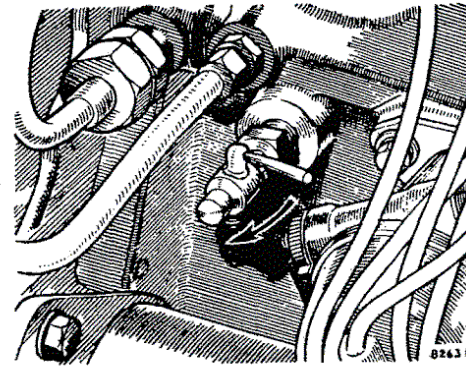

## ENGINE DRAIN TAP

To drain the water from the engine, carefully release the radiator filler cap (see page 16) and open the tap on the rear right-hand side of the cylinder block.

To drain the cooling system completely the radiator drain tap also must be opened.

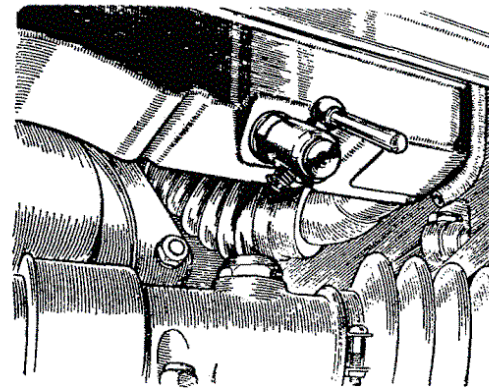

## RADIATOR DRAIN TAP

This tap is located on the front of the radiator bottom tank on the left-hand side and is accessible from below the front bumper between the number-plate and the over-rider. Release the radiator filler cap carefully (see page 16) when draining the radiator. To drain the cooling system completely the engine drain tap must also be opened.

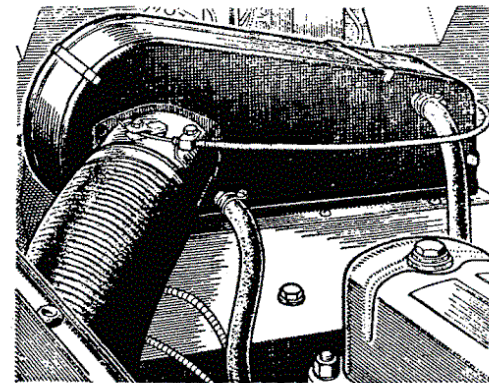

## HEATER UNIT

When a heater unit has been fitted the water cannot be drained from it completely by opening the engine and radiator drain taps, and it is essential that an anti-freeze mixture is used in the cooling system to prevent damage by freezing.

To assist draining the system when a heater unit is fitted, the temperature control lever on the heater panel should be in the right-hand or 'MAX' position.

# ELECTRICAL EQUIPMENT

# ELECTRICAL

## FUSES

### Fuse connecting 'A1' and 'A2'

This fuse protects the accessories which are connected so that they operate irrespective of whether the ignition is on or off.

### Fuse connecting 'A3' and 'A4'

This fuse protects the accessories which are connected so that they operate only when the ignition is switched on. (Stop lamps, etc.)

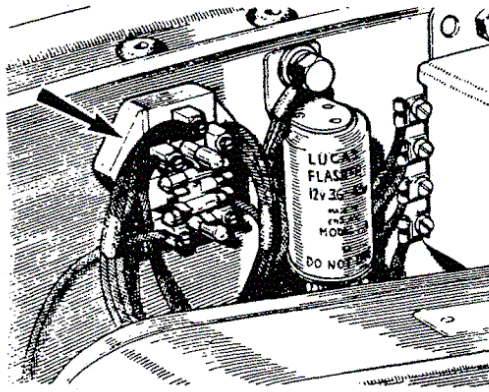

## SPARE FUSES

Spare fuses are provided and it is important to use only the correct replacement fuse. The fusing value is marked on a coloured paper slip inside the glass tube of the fuse. If the new fuse blows immediately and the cause of the trouble cannot be found, have the equipment examined at a Lucas Service Depot.

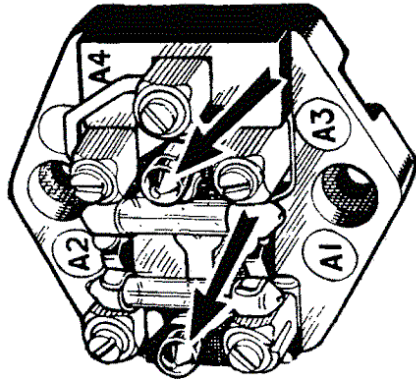

## JAMMED STARTER PINION

In the event of the starter pinion becoming jammed in mesh with the flywheel, it can usually be freed by turning the starter armature by means of a spanner applied to the shaft extension at the commutator end. This is accessible after removing the small protective cap.

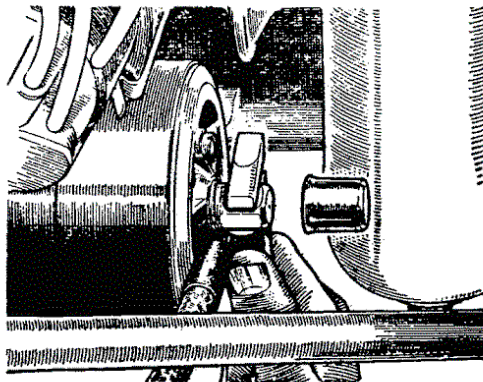

# ELECTRICAL

## WINDSHIELD WIPER BLADES

To reposition the wiped area on the glass the arm must be withdrawn from the spindle, after pressing the spring retaining clip (1), and then refitted on another spline (2).

To disengage a blade, pull the arm away from the windshield and pivot the blade upwards.

When fitting a new rubber, withdraw the old squeegee from the flexible carrier, taking care not to lose the locating pins.

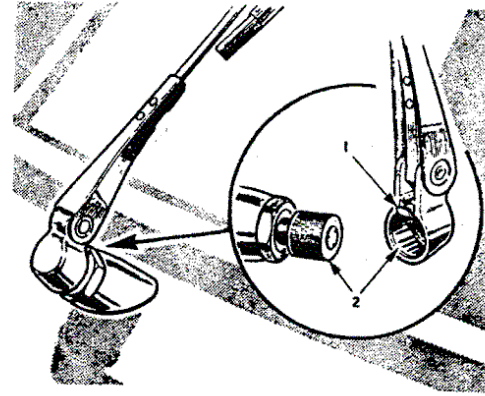

## REMOVING THE LIGHT UNIT

To remove the light unit for bulb replacement, unscrew the securing screw at the bottom of the lamp rim and lift off the rim. Remove the dust-excluding rubber.

Press the light unit inwards against the tension of the three springs and turn it in an anti-clockwise direction until the heads of the retaining screws can pass through the enlarged ends of the keyhole slots in the rim.

Reverse this procedure to replace the light unit. The rubber seal is marked 'FRONT' for correct replacement.

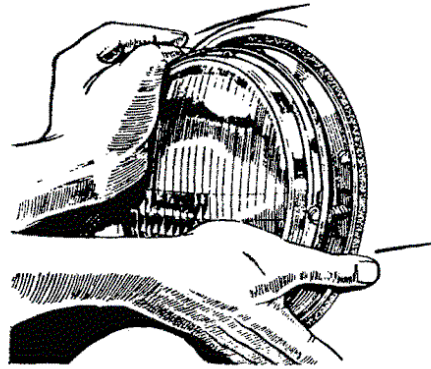

## REPLACING HEADLAMP BULBS

Withdrawal of the light unit (1) gives immediate access to the bulb carrier. Twist the back-shell (2) anti-clockwise and pull it off. The bulb can then be withdrawn from its holder (3).

Fit the replacement bulb in the holder, with the slot in its disc in engagement with the projection in the holder. Engage the projections on the back-shell with the holder slots, press on and twist to the right until its catch engages.

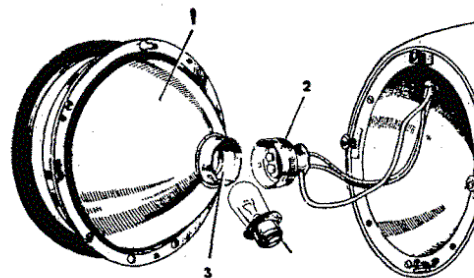

# ELECTRICAL

## SETTING HEADLAMPS

The lamps should be set so that the main driving beams are parallel with the road surface or in accordance with local regulations. If adjustment is required, remove the rim as described on page 37. Vertical adjustment is made by turning the screw at the top of the lamp. Horizontal adjustment can be effected by using the adjustment screws on each side of the light unit.

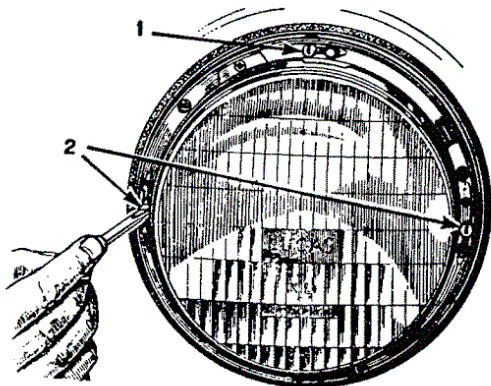

## PILOT LAMPS

To reach the bulb, push the lamp front inwards and turn it anti-clockwise until it is free to be withdrawn. Reverse the movement to replace the front.

The locating pins on the bulb are offset to ensure that it is fitted correctly to give increased brilliance when the flashing equipment is operating.

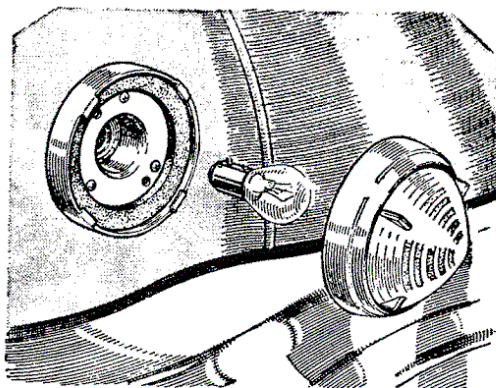

## NUMBER-PLATE LAMP

The number-plate lamp only operates when the sidelights and tail lights are switched on.

A single bayonet-fixing bulb is fitted and the cover may be removed after slackening the small retaining screw.

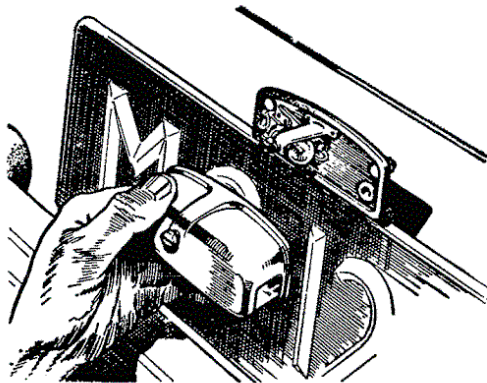

# ELECTRICAL

## TAIL AND STOP LAMPS

Each lamp cover is secured by two screws and the bulb is accessible after the cover and rubber seal are removed.

The dual-filament tail and stop lamp bulb must provide the brighter light for stop and direction indication, and to ensure this the bulb has offset pegs and can only be fitted in one position.

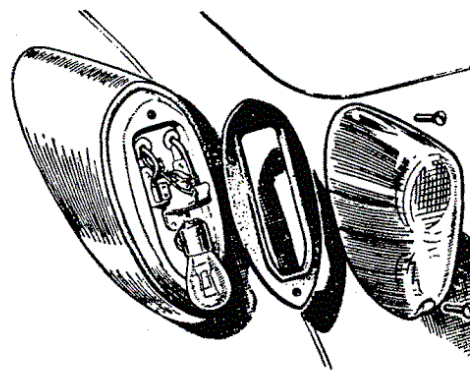

## PANEL, MAP, AND WARNING LIGHTS

There are four lamps illuminating the instruments, and their locations, together with the three warning lamps and map lamp, are shown by the arrows in the accompanying illustration.

The bulbs are accessible from below the instrument panel.

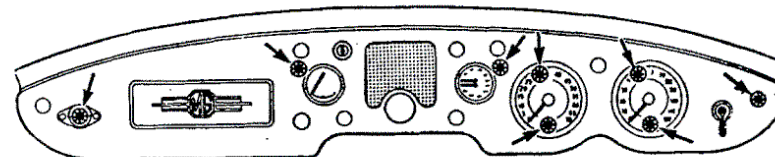

## REPLACEMENT BULBS (12-VOLT)

	Watts		Lucas No.
Headlamps, Home and Export (R.H.D.—dip left) .. .. .	42/36	(prefocus)	354
Headlamps, Export and U.S.A. (L.H.D.—dip right) .. .. .	36/36	(prefocus)	301
Headlamps, Export (Europe, except France) ..	45/35	(prefocus)	360
Sidelamp and stop/tail lamp (irreversible) ..	6/18	(S.B.C.)	361
Number-plate lamp .. .. .	4	(M.C.C.)	222
Panel lights and warning lights .. .. .	2·2	(M.E.S.)	987

# ELECTRICAL

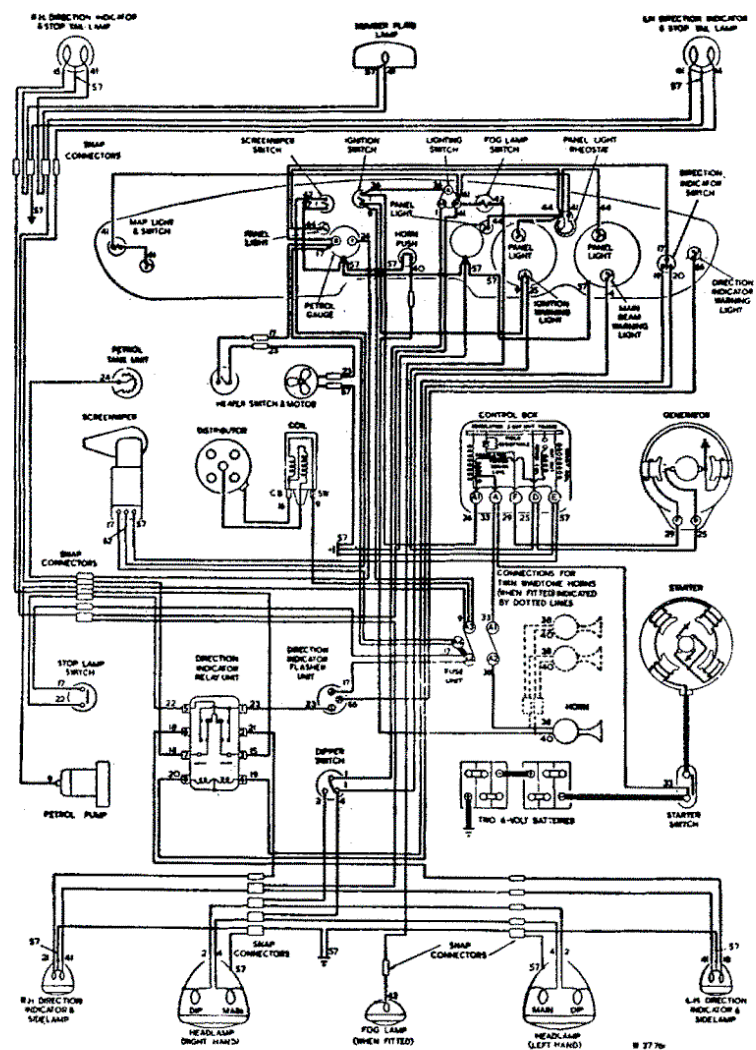

## KEY TO CABLE COLOURS

- |                      |                       |                      |                       |
|----------------------|-----------------------|----------------------|-----------------------|
| 1 Blue               | 18 Green with Red     | 35 Brown with Yellow | 51 Purple with Yellow |
| 2 Blue with Red      | 19 Green with Yellow  | 36 Brown with Blue   | 52 Purple with Blue   |
| 3 Blue with Yellow   | 20 Green with Blue    | 37 Brown with White  | 53 Purple with White  |
| 4 Blue with White    | 21 Green with White   | 38 Brown with Green  | 54 Purple with Green  |
| 5 Blue with Green    | 22 Green with Purple  | 39 Brown with Purple | 55 Purple with Brown  |
| 6 Blue with Purple   | 23 Green with Brown   | 40 Brown with Black  | 56 Purple with Black  |
| 7 Blue with Brown    | 24 Green with Black   | 41 Red               | 57 Black              |
| 8 Blue with Black    | 25 Yellow             | 42 Red with Yellow   | 58 Black with Red     |
| 9 White              | 26 Yellow with Red    | 43 Red with Blue     | 59 Black with Yellow  |
| 10 White with Red    | 27 Yellow with Blue   | 44 Red with White    | 60 Black with Blue    |
| 11 White with Yellow | 28 Yellow with White  | 45 Red with Green    | 61 Black with White   |
| 12 White with Blue   | 29 Yellow with Green  | 46 Red with Purple   | 62 Black with Green   |
| 13 White with Green  | 30 Yellow with Purple | 47 Red with Brown    | 63 Black with Purple  |
| 14 White with Purple | 31 Yellow with Brown  | 48 Red with Black    | 64 Black with Brown   |
| 15 White with Brown  | 32 Yellow with Black  | 49 Purple            | 65 Dark Green         |
| 16 White with Black  | 33 Brown              | 50 Purple with Red   | 66 Light Green        |
| 17 Green             | 34 Brown with Red     |                      |                       |

## SERVICE ADJUSTMENTS



## SERVICE ADJUSTMENTS

### TOP DEAD CENTRE

The rim of the crankshaft pulley is marked with a notch which will coincide with the longest of the three pointers on the timing chain case when No. 1 and No. 4 pistons are in the T.D.C. position.

The two pointers next to the T.D.C. pointer indicate the 5° and 10° position B.T.D.C.

The ignition timing should be set 7° B.T.D.C.

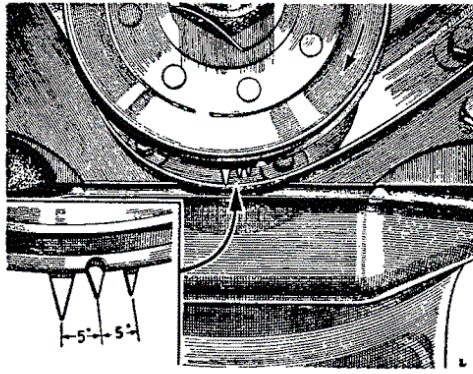

### DISTRIBUTOR ADVANCE ADJUSTMENT

The automatic advance of the distributor timing is controlled by the induction manifold vacuum and a centrifugal mechanism. In addition, a vernier adjustment is provided to give control over the actual ignition point with varying conditions and fuel. Turn the milled nut clockwise to retard the ignition or anti-clockwise to advance and note the degree of change on the scale.

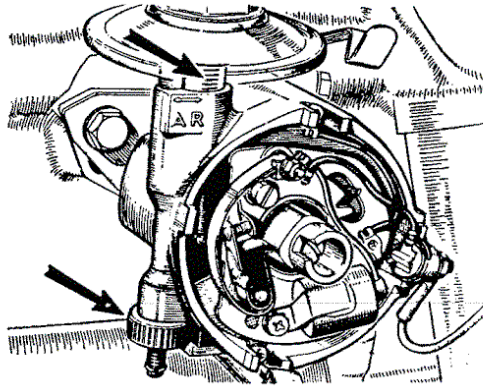

### VALVE CLEARANCES

Both inlet and exhaust valves should have a clearance of at least .017 in. (.43 mm.) when hot. It is of utmost importance to set

No. 1 valve with No. 8 fully open	
No. 3 " " No. 6 " "	
No. 5 " " No. 4 " "	
No. 2 " " No. 7 " "	
No. 8 " " No. 1 " "	
No. 6 " " No. 3 " "	
No. 4 " " No. 5 " "	
No. 7 " " No. 2 " "	

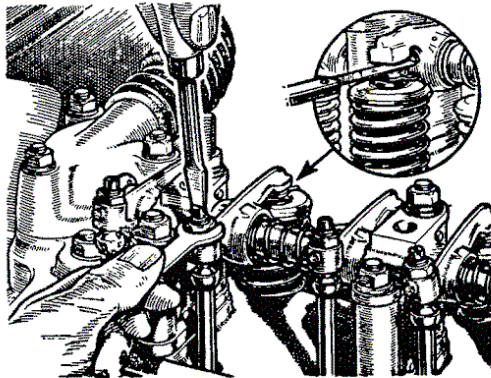

## SERVICE ADJUSTMENTS

### BRAKE ADJUSTMENT

Excessive brake pedal travel is an indication that the brake-shoes require adjusting. The brakes on all four wheels must be adjusted to regain even and efficient braking.

When relining front or rear brake-shoes it is important that the shoes on both sides of the car are attended to at the same time. Never reline the shoes for one side without attending to the opposite side.

The arrows indicate the screws of a front brake after the wheel, brake-drum and hub have been removed.

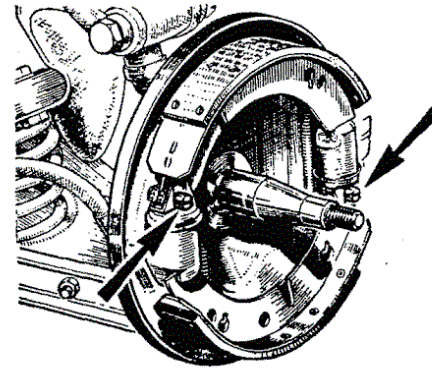

### FRONT BRAKES

Apply the hand brake and use the jack to raise each wheel in turn. Remove the hub cap and rotate the wheel until one adjustment screw is visible through the small hole provided. Turn the screw in a clockwise direction until the wheel is locked, then turn anti-clockwise one notch only. The wheel should be free to rotate without the shoes rubbing. Turn the wheel until the opposite screw is visible; repeat procedure. Adjust the brakes on the other front wheel in a similar way.

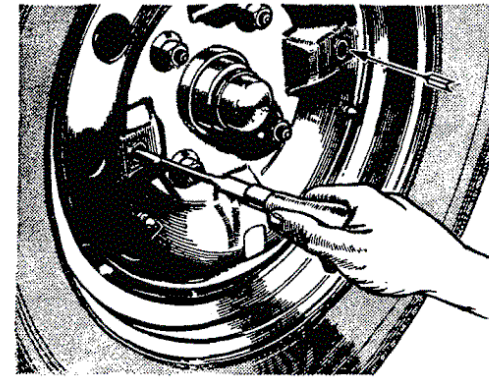

### REAR BRAKES

The adjustment procedure is similar to that detailed above for the front brakes, except that one adjuster in each wheel controls both brake-shoes.

Place blocks against the wheels remaining on the ground as it is essential that the hand brake should be fully released while the rear brake-shoes are being adjusted. Adjustment of the rear brake-shoes automatically adjusts the hand brake mechanism and no separate adjustment is required.

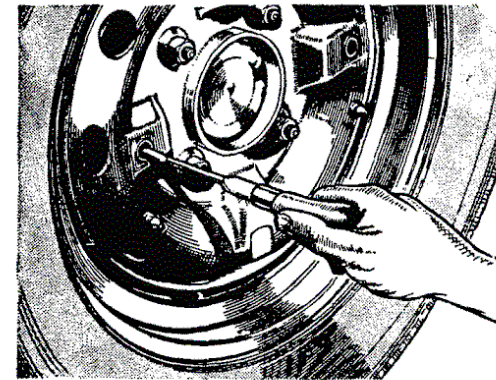

## SERVICE ADJUSTMENTS

### ADJUSTING THE JETS

Run the engine until it attains its normal running temperature and release the inter-carburetter throttle and mixture linkage. Set the slow-running screws on the carburetter throttle actuating levers so that the throttles are both open the same amount. This is indicated by the same suction noise at each carburetter.

Disconnect the mixture control wire from the end of the brass lever actuating the rear jet, and screw the jet adjusting nuts well downwards. Note that the jet actuating levers must be kept in contact with the jet heads the whole time.

The jet adjusting nuts should now be screwed upwards slowly (thus gradually weakening the mixture) until the engine idles evenly, firing on all cylinders regularly, and running at its best speed. This will be the normal slow-running position when the engine is hot, and as the jet needles are of the correct size the general performance on the road should be entirely satisfactory. Check by raising each carburetter piston with the pin indicated by the arrow. If the engine speed increases momentarily the setting is right. If the engine stalls the setting is too weak. If the engine speed increases permanently it is too rich.

The mixture control wire may be re-connected when the adjustment is satisfactory, care being taken to see that the control knob has ample clearance when the jet heads are in contact with the adjusting nuts. Final adjustment for slow-running is then carried out by adjusting each of the carburetter throttle lever stop screws an equal amount before reconnecting the throttle and mixture linkage.

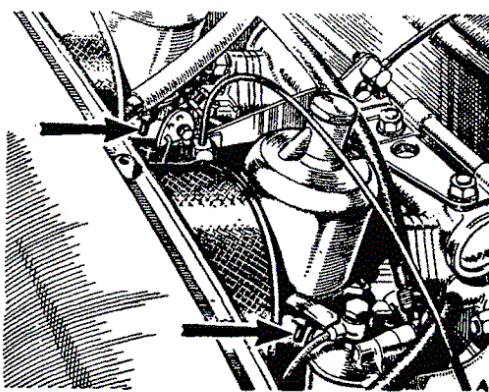
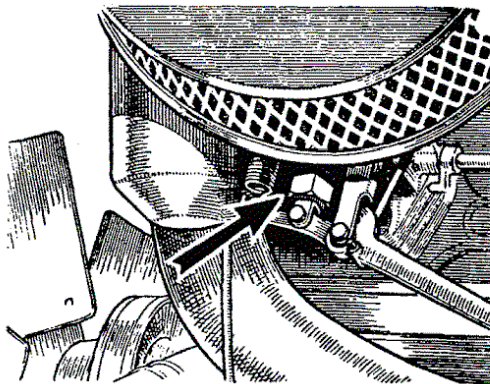
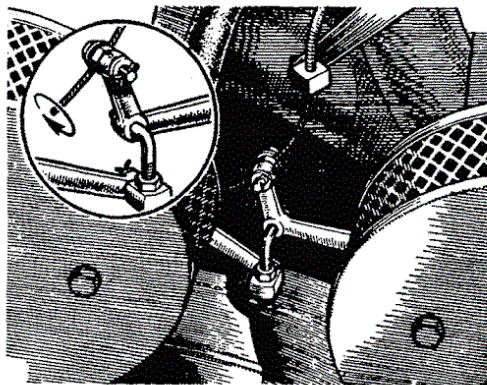

## SERVICE ADJUSTMENTS

### SLOW-RUNNING ADJUSTMENT

Slow-running adjustments are carried out by adjusting the position of the carburetter throttle lever stop screws, which are spring-loaded, until gentle slow-running is attained.

Make sure that there is a small clearance between the mixture and throttle interconnecting lever and its abutment screw.

It is important that both carburetters are set exactly alike and you are advised to entrust this to an M.G. Dealer.

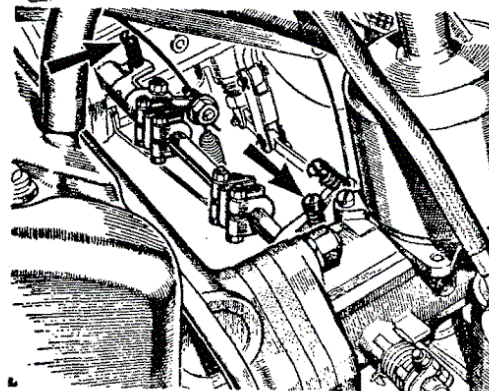

### MIXTURE CONTROL LINKAGE ADJUSTMENT

When the mixture control knob on the instrument panel is right home there must be a small gap between the adjusting screw and the interconnecting lever on the front carburetter. This gap determines the degree of interlinkage between the throttle and the mixture control and should be set so that there is just clearance between the end of the adjusting screw and the anvil of the rocking lever linked to the jet operating lever.

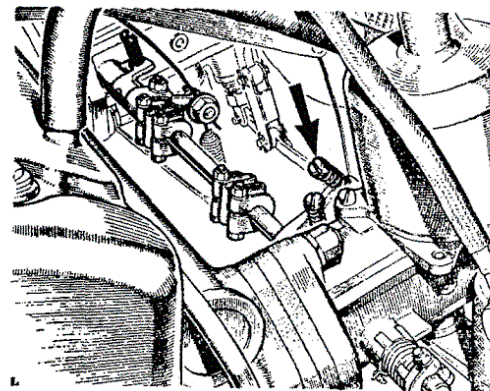



## MAINTENANCE PROCEDURE

# 500 MILES FREE SERVICE

## 500 MILES (800 Km.) FREE SERVICE

During the early life of the car, soon after it has completed 500 miles (800 km.), you are entitled to have it inspected free of charge by the M.G. Dealer from whom you purchased it, or, if this should not be convenient, by any other M.G. Dealer by arrangement. This attention given during the critical period in the life of the car makes all the difference to its subsequent life and performance.

### This service includes:

- 1. Engine**  
Tighten cylinder head and manifold nuts to recommended pressures.  
Check tightness of valve rocker shaft brackets to recommended pressures.  
Check valve rocker clearances, and reset if necessary.  
Tighten fan belt if necessary.  
Check all water connections, and tighten clips if necessary.  
Examine and clean carburetters, and reset slow-running adjustment if necessary.
- 2. Ignition**  
Examine, and adjust if necessary, sparking plugs and distributor points.  
Check working of automatic ignition control and, if necessary, reset ignition timing.
- 3. Clutch**  
Check clutch pedal for free movement, and bleed if necessary.
- 4. Steering**  
Check front wheel alignment and steering connections; adjust if necessary.
- 5. Brakes**  
Check braking system functionally, and bleed lines if necessary.  
Check fluid level in master cylinder, and top up if necessary.
- 6. Hydraulic dampers**  
Inspect hydraulic dampers for leaks.  
Examine oil levels, and top up if necessary (piston type only).
- 7. Body**  
Check doors for ease in opening and closing.  
If necessary, lightly smear with a suitable lubricating agent all dovetails and striking plates.
- 8. Electrical**  
Check electrical system functionally.  
Examine battery, and top up to correct level with distilled water or diluted acid as may be required. Clean and tighten terminals.
- 9. General**  
Check tightness of universal joint nuts, spring clips, and wing (fender) bolts.
- 10. Lubrication**  
Drain oil from engine, gearbox and rear axle and refill.  
Oil and grease all points of car.
- 11. Wheels and tyres**  
Test tyres for correct pressures.  
Check tightness of wheel nuts.

ALL MATERIALS CHARGEABLE TO THE CUSTOMER

# PERIODICAL ATTENTION

## Daily

Inspect oil level in crankcase. Refill if necessary, (See page 17.)  
See that radiator is full of water.

## Weekly

Test tyre pressures. (See page 17.)

## 1,000 miles (1600 km.) service

- 1. Engine**  
Top up carburetter piston dashpots.  
Lubricate carburetter controls.  
Top up radiator.
- 2. Clutch**  
Check level of fluid in the hydraulic clutch and brake master cylinder.
- 3. Brakes**  
Check brake pedal free travel, and report if adjustment is required.  
Make visual inspection of brake lines and pipes.  
Check level of fluid in hydraulic brake and clutch master cylinder.
- 4. Hydraulic dampers**  
Examine all hydraulic dampers for leaks.
- 5. Electrical**  
Check battery cell specific gravity readings and top up to correct level.
- 6. Lubrication**  
Top up engine, gearbox, and rear axle oil levels.  
Lubricate all grease nipples (except steering rack and pinion).
- 7. Wheels and tyres**  
Check tyre pressures.  
Check wheel nuts for tightness.

# PERIODICAL ATTENTION

## 2,000 miles (3200 km.) service

Carry out the 1,000 miles (1600 km.) service.

## 3,000 miles (4800 km.) service

- 1. Engine**  
Top up carburetter piston dashpots.  
Lubricate carburetter controls.  
Top up radiator.  
Check dynamo drive belt tension.  
Clean and re-oil air cleaner elements.  
Dismantle oil filter element and bowl and wash in petrol.
- 2. Ignition**  
Check automatic ignition control, lubricating distributor drive shaft and cam and advance mechanism.  
Check, and adjust if necessary, distributor contact points.
- 3. Clutch**  
Check level of fluid in the hydraulic clutch and brake master cylinder.
- 4. Brakes**  
Check brakes, and adjust if necessary.  
Change wheels round diagonally, including spare, to regularize tyre wear.
- Make visual inspection of brake lines and pipes.  
Check level of fluid in the hydraulic brake and clutch master cylinder.
- 5. Hydraulic dampers**  
Examine all hydraulic dampers for leaks.
- 6. Body**  
Lubricate door hinges, bonnet lock, and operating mechanism.
- 7. Electrical**  
Check battery cell specific gravity readings and top up to correct level.  
Lubricate dynamo bearing.
- 8. Lubrication**  
Change engine oil.  
Top up gearbox and rear axle oil levels.  
Lubricate all grease nipples (except steering rack and pinion).
- 9. Wheels and tyres**  
Check tyre pressures.

## 4,000 miles (6400 km.) service

Carry out the 1,000 miles (1600 km.) service.

## 5,000 miles (8000 km.) service

Carry out the 1,000 miles (1600 km.) service, with the following addition:

- 1. Engine**  
Clean and adjust sparking plugs.
- 6,000 miles (9600 km.) service**
  - 1. Engine**  
Top up carburetter piston dashpots.  
Lubricate carburetter controls.  
Top up radiator.  
Check dynamo drive belt tension.  
Lubricate water pump sparingly.  
Check valve rocker clearances, and adjust if necessary.  
Clean and re-oil air cleaner elements.  
Clean carburetter and fuel pump filters.
  - 2. Ignition**  
Check automatic ignition control, lubricating distributor drive shaft and cam and advance mechanism.  
Check, and adjust if necessary, distributor contact points.
  - 3. Clutch**  
Check level of fluid in the hydraulic clutch and brake master cylinder.
  - 4. Brakes**  
Check brakes, and adjust if necessary.  
Change road wheels round diagonally to regularize tyre wear.  
Make visual inspection of brake lines and pipes.  
Check level of fluid in the hydraulic brake and clutch master cylinder.
  - 5. Hydraulic dampers**  
Examine all hydraulic dampers for leaks and check fluid level in front dampers.
  - 6. General**  
Tighten rear road spring seat bolts.
  - 7. Body**  
Check, and tighten if necessary, door hinges and striker plate securing screws.  
Lubricate door hinges, bonnet lock, and operating mechanism.
  - 8. Electrical**  
Check battery cell specific gravity readings and top up to correct level.  
Lubricate dynamo bearing.
  - 9. Lubrication**  
Change oil in engine, gearbox, and rear axle.  
Fit new oil filter element.  
Lubricate all grease nipples (except steering rack and pinion).  
Repack front hub caps with grease.
  - 10. Wheels and tyres**  
Check tyre pressures.  
Check wheel alignment.

# PERIODICAL ATTENTION

## 7,000 miles (11200 km.) service

Carry out the 1,000 miles (1600 km.) service.

## 8,000 miles (12800 km.) service

Carry out the 1,000 miles (1600 km.) service.

## 9,000 miles (14400 km.) service

Carry out the 1,000 miles (1600 km.) service.

## 10,000 miles (16000 km.) service

Carry out the 1,000 miles (1600 km.) service, with the following addition:

1. *Engine*  
Fit new sparking plugs.

## 11,000 miles (17600 km.) service

Carry out the 1,000 miles (1600 km.) service.

## 12,000 miles (19200 km.) service

1. *Engine*  
Remove carburetter suction chambers and pistons, clean, reassemble, and top up. Remove carburetter float-chambers, empty sediment, and refit. Lubricate carburetter controls. Check valve rocker clearances, and adjust if necessary. Clean and re-oil air cleaner elements. Check dynamo drive belt tension. Lubricate water pump sparingly. Clean carburetters and fuel pump filters.
2. *Ignition*  
Check automatic ignition control, lubricating distributor drive shaft and cam and advance mechanism. Check, and adjust if necessary, distributor contact points.
3. *Clutch*  
Check level of fluid in the hydraulic clutch and brake master cylinder.
4. *Steering*  
Check steering and suspension moving parts for wear.
5. *Brakes*  
Check brakes, and adjust if necessary. Change road wheels round diagonally, including spare, to regularize tyre wear. Make visual inspection of brake lines and pipes. Check level of fluid in the hydraulic brake and clutch master cylinder.
6. *Hydraulic dampers*  
Examine all hydraulic dampers for leaks, and top up if necessary.
7. *Radiator*  
Drain, flush out, and refill radiator.
8. *General*  
Tighten rear road spring seat bolts.
9. *Body*  
Check, and tighten if necessary, door hinges and striker plate securing screws. Lubricate door hinges, bonnet lock, and operating mechanism.
10. *Electrical*  
Check battery cell specific gravity readings and top up to correct level. Lubricate trafficators. Lubricate dynamo bearing.
11. *Lubrication*  
Drain engine, flush out with flushing oil, and refill with fresh oil. Change oil in gearbox and rear axle. Fit new oil filter element. Lubricate steering rack and pinion. Lubricate all grease nipples. Repack front hub caps with grease.
12. *Wheels and tyres*  
Check tyre pressures. Check wheel alignment.
13. *Headlamps*  
Check headlamp beam setting, and reset if necessary.

## 24,000 miles (38400 km.) service

Carry out the 12,000 miles (19200 km.) service, with the following amendment:

11. *Lubrication*  
Remove engine sump and pick-up strainer, clean, and reassemble, filling with fresh oil.

Regular servicing, as proven by presentation of completed voucher counterfoils, could well enhance the value of your vehicle in the eyes of a prospective purchaser.

# EVERY 1,000 MILES (1600 Km.)

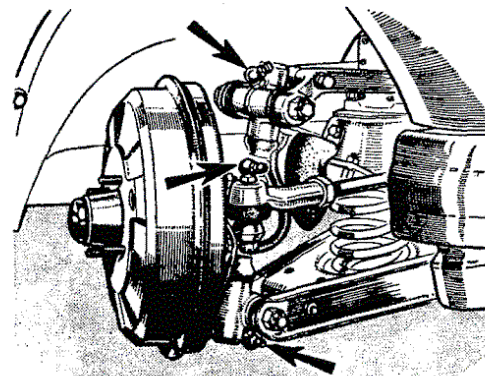

## STEERING GEAR (D)

Grease nipples are provided at the top and bottom of each swivel pin and on the steering tie-rods. The grease gun should be filled with grease to Ref. D (page 64) and applied to the nipples every 1,000 miles (1600 km.). Three or four strokes of the gun should be given.

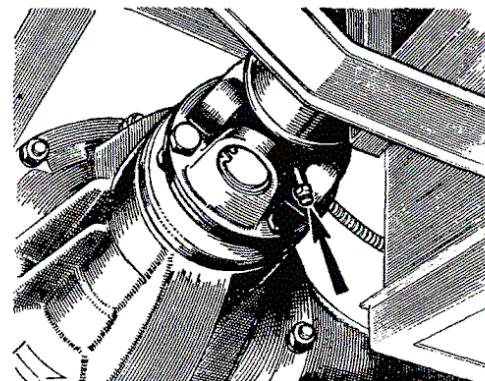

## PROPELLER SHAFT (D)

The two needle-type universal joints and the propeller shaft sliding joint should receive grease gun attention every 1,000 miles (1600 km.). The recommended lubricants are indicated under Ref. D on page 64. The joints at the front and rear ends of the propeller shaft are each provided with a grease nipple and must be lubricated from the under side of the car.

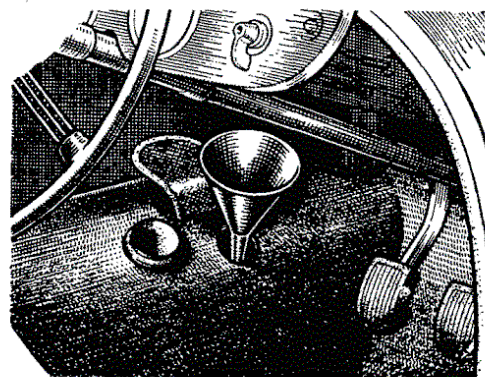

## GEARBOX (A)

Replenishments should take place at intervals of 1,000 miles (1600 km.), care being taken to ensure that the gearbox is not filled above the 'HIGH' mark on the dipstick. If the level is too high, oil may get into the clutch case and cause clutch slip. The combined filler plug and dipstick are located beneath the rubber plug on the gearbox cover.

## EVERY 1,000 MILES (1600 Km.)

### REAR AXLE (B)

The combined filler and level plug is reached from below the rear of the car and must be removed with the special key provided in the tool kit. The oil level should be checked at intervals of 1,000 miles (1600 km.), and replenished if necessary to the level of the filler plug hole.

**NOTE.**—It is essential that only Hypoid oil be used in the rear axle. (See page 64.)

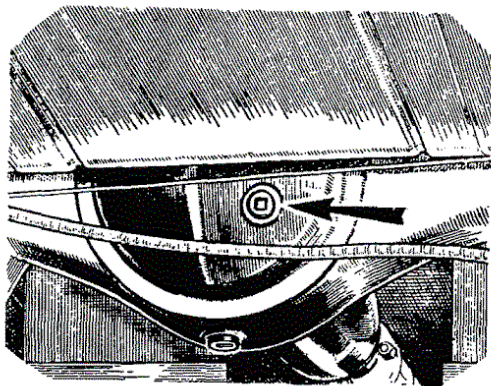

### BRAKE FLUID

Every 1,000 miles (1600 km.) remove the combined hydraulic brake and clutch master cylinder cap and check the level of the fluid.

The master cylinder is mounted on the driver's side of the dash panel below the bonnet and the level should be  $\frac{1}{4}$  in. (6.3 mm.) below the bottom of the filler neck and must never be above this.

Use only Lockheed Genuine Brake Fluid (if this fluid is not available an alternative fluid to S.A.E. Specification No. 70.R1 should be used.

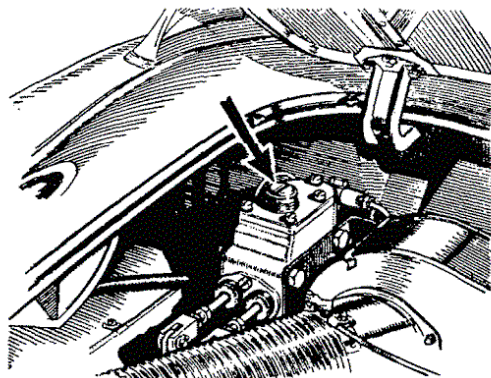

### CARBURETTOR DAMPERS (F)

Every 1,000 miles (1600 km.) unscrew the oil cap at the top of each suction chamber, pour in a small quantity of thin engine oil and replace the caps. Under no circumstances should a heavy-bodied lubricant be used.

Failure to lubricate the piston dampers will cause the pistons to flutter and reduce acceleration.

An oil indicated under Ref. F (on page 64) should be used.

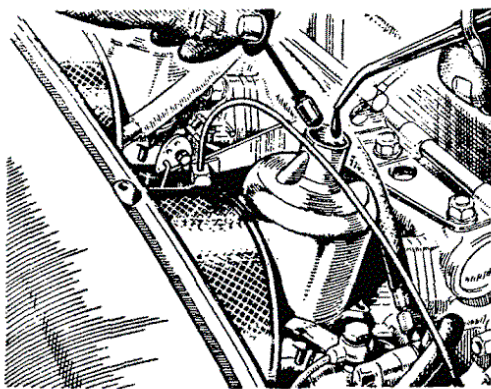

## EVERY 1,000 MILES (1600 Km.)

### BATTERIES

Every 1,000 miles (1600 km.). Raise the hood and remove the spare wheel and hood stowage floor. The floor is secured by two quick-release screws. Remove the battery cell filler plugs and add sufficient distilled water to bring the surface of the electrolyte level with the top of the separators. Take care not to overfill the cells and do not use a naked flame when examining them. Tap-water must not be used. Always clean the battery top before removing the filler plugs.

Never leave the batteries in a discharged state for any length of time. Have them fully charged, and every fortnight give them a short refreshing charge to prevent any tendency for the plates to become permanently sulphated.

### CHECKING SPECIFIC GRAVITY

Check the specific gravity of the electrolyte in each of the cells with a hydrometer. Readings should not be taken immediately after topping up the cells. The readings

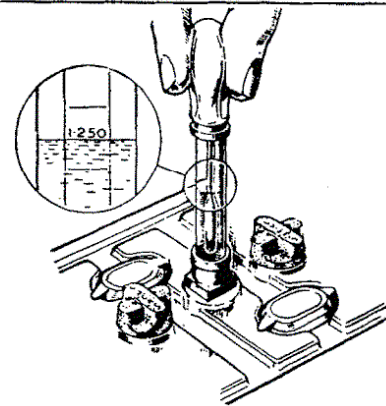

and their indications, assuming that the temperature of the solution is about 60° F. (16° C.), are as follow:  
1.280 to 1.300 Battery fully charged.

About 1.210 Battery about half-discharged.

Below 1.150 Battery fully discharged.

If one cell gives a reading very different from the rest, the battery should be examined by a Lucas Service Depot or Agent.

### HAND BRAKE CABLES

The grease nipple on the hand brake cable should be given three or four strokes with a grease gun filled with grease to Ref. E (page 64) every 1,000 miles (1600 km.).

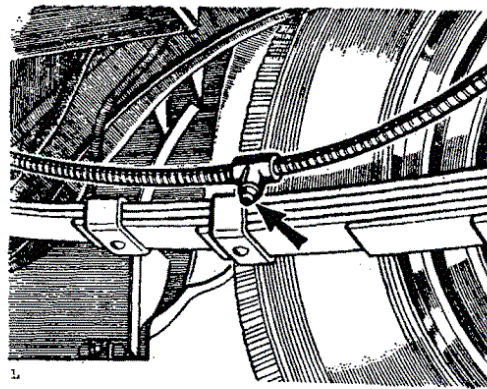

## EVERY 3,000 MILES (4800 Km.)

### DRAINING THE SUMP (A)

Drain the oil from the engine sump after 3,000 miles (4800 km.) and refill with new oil to Ref. A, page 64. The drain plug is on the right-hand side of the sump and should be removed after a journey while the oil is still warm and will drain easily.

Before refilling the sump with fresh oil remove the oil filter element, wash it and its container in fuel, and replace. The sump capacity is 8 pints (4.54 litres, 9½ U.S. pints), including the oil filter.

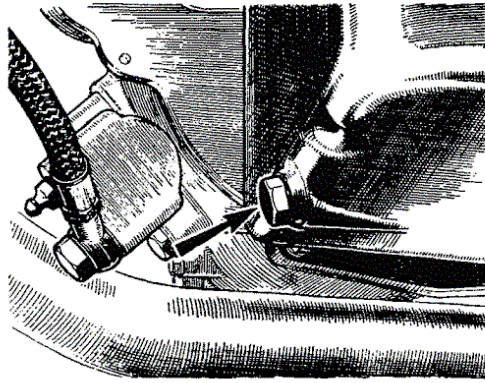

### AIR CLEANER (A)

Every 3,000 miles (4800 km.) wash the filter element in petrol (gasoline) and allow to dry. Re-oil the element with S.A.E. 20 engine oil and allow to drain before reassembling.

When servicing, it is only necessary to withdraw the two hexagon-headed screws and lift off the outer cover to release the corrugated element. Re-assemble the front element with the corrugations clear of the breather spigot in the main filter case.

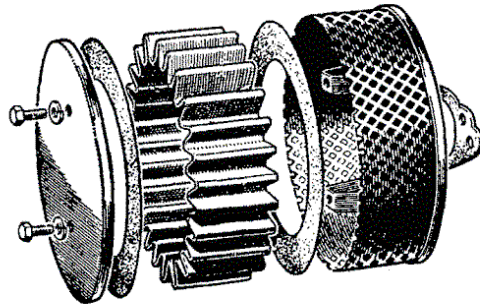

### DYNAMO LUBRICATION

Every 3,000 miles (4800 km.) add two drops of engine oil to Ref. F (page 64) in the lubrication hole in the centre of the rear end bearing plate.

**Do not over-oil.**

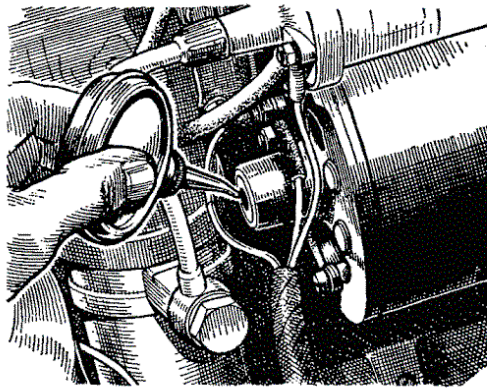

## EVERY 3,000 MILES (4800 Km.)

### DISTRIBUTOR CAM BEARING

Lift the rotor off the top of the spindle by pulling it squarely and add a few drops of thin engine oil to Ref. F (page 64) to the cam bearing. Do not remove the screw which is exposed.

There is a clearance between the screw and the inner face of the spindle for the oil to pass.

Replace the rotor with its drive lug correctly engaging the spindle slot and push it onto the shaft as far as it will go.

### DISTRIBUTOR CAM

Lightly smear the cam with a very small amount of grease to Ref. D (page 64), or if this is not available, clean engine oil can be used.

### AUTOMATIC TIMING CONTROL

Carefully add a few drops of thin engine oil to Ref. F (page 64) through the hole in the contact breaker base through which the cam passes. Do not allow oil to get on or near the contacts. Do not over-oil.

### CONTACT BREAKER PIVOT

Add a spot of engine oil to Ref. F (page 64) to moving contact pivot pin.

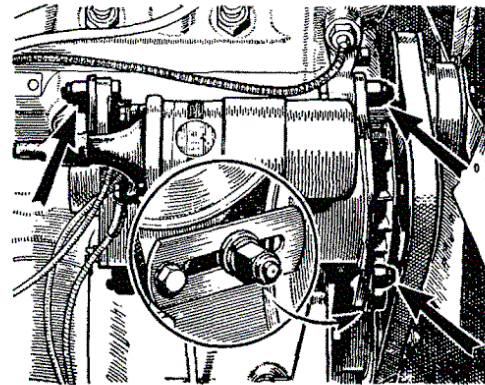
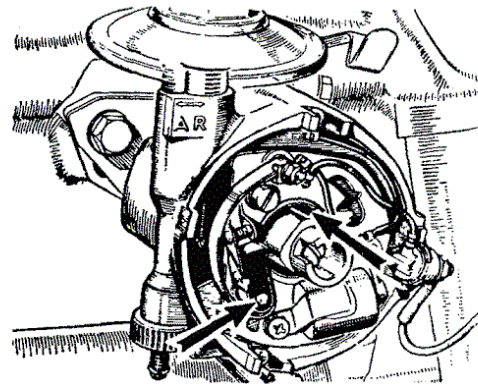
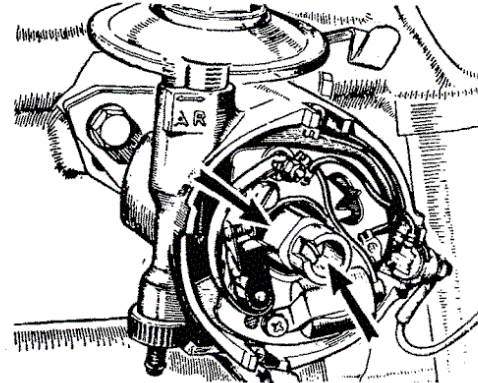

### DYNAMO DRIVING BELT

Inspect the dynamo driving belt and adjust if necessary to take up any slackness. Care should be taken to avoid overtightening the belt, otherwise undue strain will be thrown on the dynamo bearings.

The belt tension is adjusted by slackening the bolts of the dynamo cradle and moving the dynamo the required amount by hand. Tighten up the bolts thoroughly, particularly the one passing through the slotted adjusting link (inset).

## EVERY 3,000 MILES (4800 Km.)

### CLEANING THE CONTACTS

If the contacts appear pitted or blackened they should be removed and cleaned with a fine carborundum stone or fine emery-cloth.

To release the contacts remove the nut, plain washer, and insulator from the retaining post and lift off the moving contact and the two insulating washers. Take out the two screws and remove the contact plate.

Set the gap after replacing.

Wipe the inside and outside of the distributor cap to ensure that it is clean.

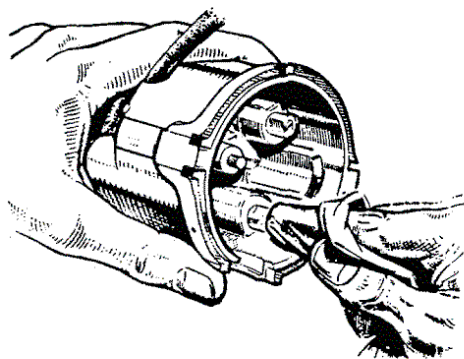

### CONTACT BREAKER GAP

Every 3,000 miles (4800 km.) check the contact gap with the gauge on the small screwdriver in the tool kit. Turn the engine with the starting handle until the contacts are fully open and the gauge should then be a sliding fit. If the gap varies appreciably, slacken the contact plate screw, insert a screwdriver in the cut-out and move the plate until the gap is correct. Retighten the screw.

The correct gap is .014 to .016 in. (.36 to .41 mm.) and the gauge is .016 in. thick.

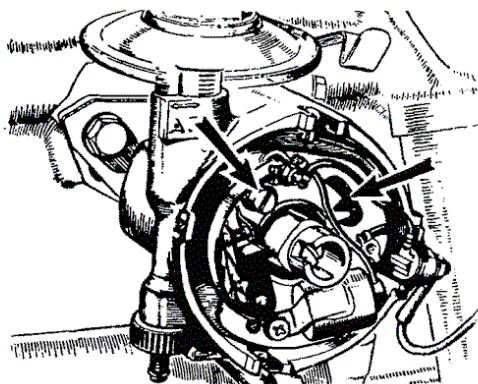

## EVERY 5,000 MILES (8000 Km.)

### SPARKING PLUGS

The sparking plugs should be cleaned preferably by a garage with a special air blast service unit, and the gaps should be reset to .019 in. (.48 mm.) every 5,000 miles (8000 km.). Use the special Champion sparking plug gauge and setting tool and move the side wire on the plug, never the centre one. Plugs which are oily, dirty or corroded cannot give good results. Fit a set of new plugs every 10,000 miles (16000 km.).

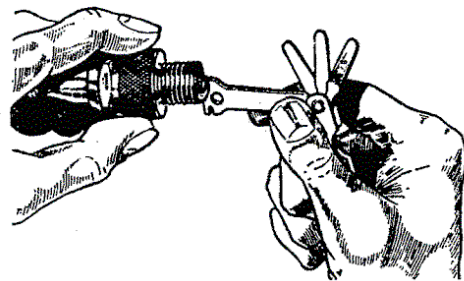

## EVERY 6,000 MILES (9600 Km.)

### DRAINING THE GEARBOX (A)

Drain the gearbox oil every 6,000 miles (9600 km.), using the special key in the tool kit to remove the drain plug.

When the gearbox has been drained completely, 4 Imperial pints (2.2 litres, 4.8 U.S. pints) of oil are required to refill it. The oil should be poured in through the filler plug shown on page 51.

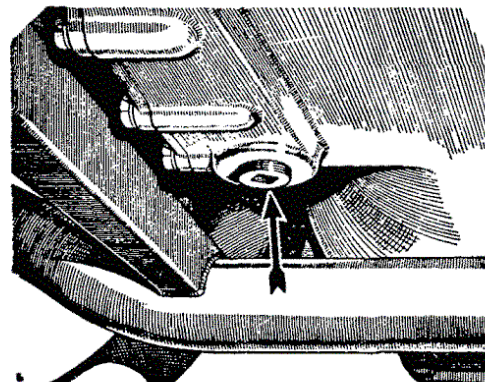

### REAR AXLE (B)

Remove the drain plug with the special key in the tool kit and drain out the oil every 6,000 miles (9600 km.). Refill with Hypoid oil to Ref. B (page 64) to the level of the filler plug hole.

Approximately 2½ pints (1.56 litres, 3.5 U.S. pints) of oil are required to refill the axle.

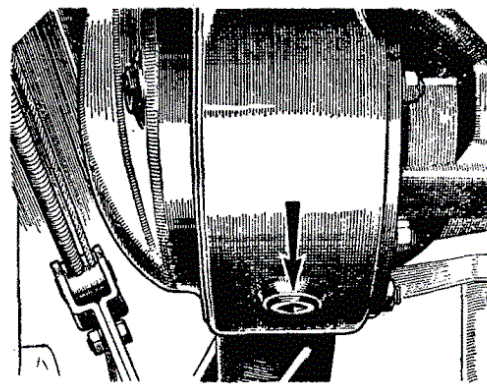

### FRONT WHEEL HUBS (C)

Every 6,000 miles (9600 km.) the front wheel hub covers should be removed and the grease-retaining cap carefully prised off the end of each hub, refilled with grease to Ref. C (page 64) and replaced.

To lubricate the front hubs on cars fitted with wire wheels, the wheel retaining nuts must be unscrewed with the copper mallet in the tool kit (see page 23) and the hubs packed with grease to Ref. C (page 64).

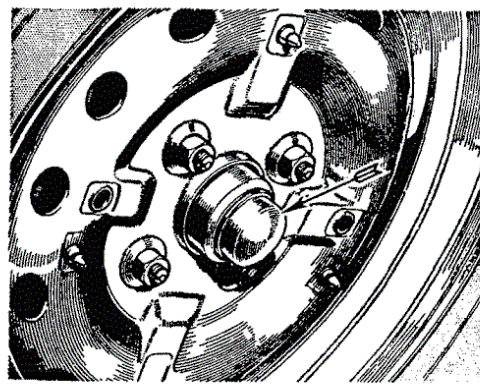



## EVERY 6,000 MILES (9600 Km.)

### OIL FILTER

The engine oil filter element must be renewed every 6,000 miles (9600 km.). The filter is released by undoing the central bolt securing the filter body to the filter head. When fitting the new element, make sure that the seating washer for the filter body is in good condition and that the body is correctly fitted.

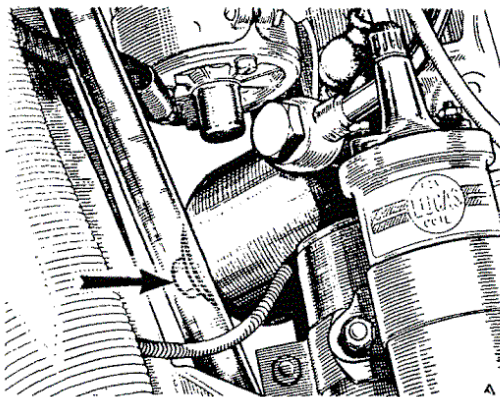

### CARBURETTOR FILTERS

To ensure a free flow of fuel to the float-chambers the filters should be removed at intervals of about 6,000 miles (9600 km.) and thoroughly cleaned with a stiff brush and fuel. Never use rag. The filters are situated behind the banjo-type union at the junction of the fuel pipe to each float-chamber lid.

Replace the filters with their helical springs first and their open ends outwards. Replace the fibre washers correctly.

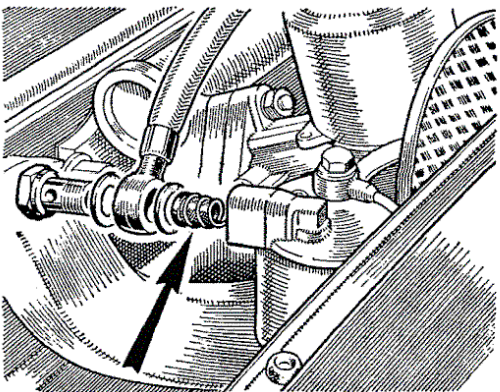

### FUEL PUMP FILTER

Every 6,000 miles (9600 km.) clean off the fuel pump, withdraw the filter and clean it thoroughly in fuel. The filter is inserted into the bottom of the pump body and is released by unscrewing the hexagon plug.

When cleaning the filter do not use rag—always use a stiff brush and clean fuel. The fuel pump is fitted beneath the hood stowage compartment floor. Raise the hood and remove the spare wheel. The floor is removed by releasing the two quick-release screws.

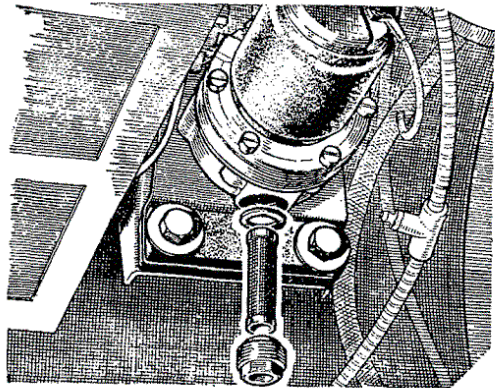

## EVERY 6,000 MILES (9600 Km.)

### FRONT DAMPERS

Thoroughly clean the damper bodies in the area surrounding the filler plugs. Remove the filler plugs and top up to the level of the bottom of the filler plug hole.

The use of Armstrong Super (Thin) Shock Absorber Fluid No. 624 is recommended for use in the dampers. If this fluid is not available a good-quality mineral oil conforming to Specification 20/20W may be used. This alternative is not suitable for low-temperature operation and is also deficient in various other ways.

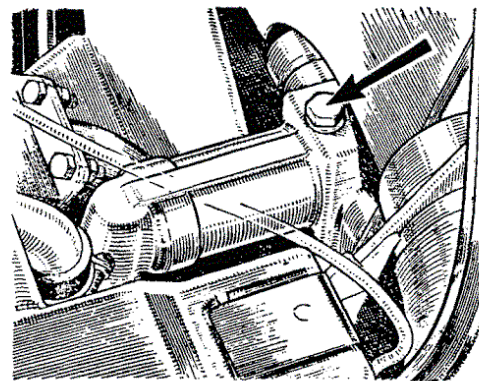

### FRONT WHEEL ALIGNMENT

Excessive and uneven tyre wear is usually caused by faulty wheel alignment. The front wheels should be set parallel, and care should be taken that the measurements are taken at axle level and that the rims run true.

Since correct alignment is so important and entails the use of a special gauge, this work should be entrusted to an Authorized M.G. Dealer.

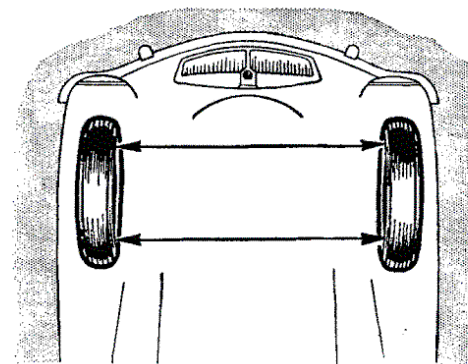

### WATER PUMP

Every 6,000 miles (9600 km.) remove the water pump oil plug on the water pump casing and add a small quantity of S.A.E. 140 oil. The lubrication of the pump must be done sparingly, otherwise oil will flow past the bearings onto the face of the carbon sealing ring and impair its efficiency.

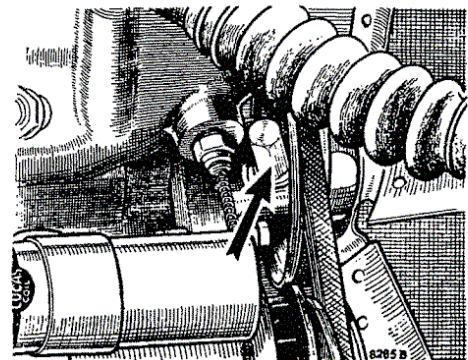

## EVERY 12,000 MILES (19200 Km.)

### REAR DAMPERS

Remove the rear dampers and clean the bodies thoroughly. Remove the filler plugs and top up to the level of the bottom of the filler plug hole. The use of Armstrong Super (Thin) Shock Absorber Fluid No. 264 is recommended for use in the dampers. If this fluid is not available a good-quality mineral oil conforming to Specification 20/20W may be used. This alternative is not suitable for low-temperature operation and is also deficient in various other ways.

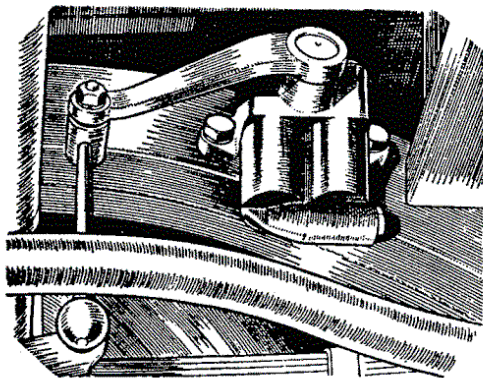

### STEERING GEARBOX

The two oil nipples for the steering gearbox and pinion are reached from under the bonnet.

Give the gearbox nipple 10 strokes **only** every 12,000 miles (19200 km.) and give the pinion nipple two strokes **only** at the same time with a gun filled with oil to Ref. B (page 64).

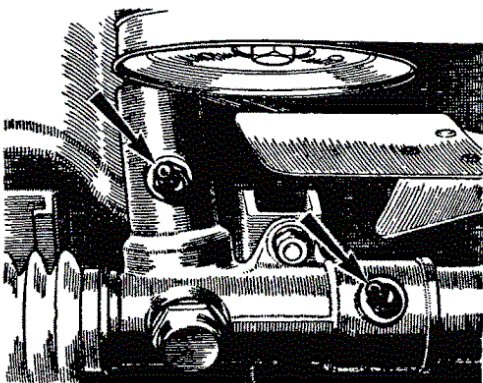

### ENGINE FLUSHING

Remove the engine sump drain plug and allow the old oil to drain completely. Replace the plug and pour in through the engine filler cap approximately 4 pints (2.27 litres, 4.8 U.S. pints) of flushing oil. A flushing oil supplied by one of the recommended lubricant manufacturers (page 64) should be used. Run the engine at fast tick-over speed for 2½ to 3 minutes. After stopping the engine special care must be taken to ensure complete drainage of the flushing oil.

Replace the sump drain plug and fill the engine with oil to Ref. A (page 64).

## IMPORTANT

Your attention is drawn to the following points, compliance with which, we suggest, will prove mutually beneficial.

### 1. WARRANTY CERTIFICATE

- (a) Completion of the Warranty Certificate 'tear-off slip' at the time of vehicle purchase when sent to the Factory will ensure registration of ownership by the British Motor Corporation.
- (b) Retention of the Owner's portion of the Certificate, signed by the Distributor and Owner, in a safe place in the vehicle (by quickly establishing ownership) will help to expedite any adjustments under Warranty if such adjustments are required to be carried out by a B.M.C. Distributor and Dealer other than the supplier of your vehicle.

### 2. CLAIMS UNDER WARRANTY

Claims for the replacement of material or parts under Warranty must always be submitted to the supplying Distributor or Dealer or, when this is not possible, to the nearest Distributor or Dealer, informing them of the Vendor's name and address.

### 3. PREVENTIVE MAINTENANCE

Service vouchers (applicable in the United Kingdom only) are produced for your convenience, and the use of these is the best safeguard against the possibility of abnormal repair bills at a later date. Prevent rather than Cure.

### 4. REPLACEMENT PARTS

When Service Parts are required insist on genuine B.M.C. (MOWOG) Parts as these are designed and tested for your vehicle and in addition warranted for 12 months by the British Motor Corporation. **ONLY WHEN GENUINE PARTS ARE USED CAN B.M.C. ACCEPT RESPONSIBILITY.**



When purchasing replacement parts or having repairs done owners are requested to see that a label similar to the one illustrated here is attached to the invoice rendered. These labels are issued by B.M.C. Service Ltd. or Nuffield Exports Ltd. and constitute a guarantee that genuine B.M.C. parts are supplied.

Our world-wide network of Distributors and Dealers is at your service.

# INDEX

A			Page
Adjusting the fuel mixture (jet)	44	Engine oil, checking	17
Adjustment, brake	43	Engine oil, filling	17
Adjustment, distributor advance	42	External oil filter	58
Adjustment, seat	7		
Adjustment, slow-running	45	<b>F</b>	
Adjustments, steering column	41	Filter, fuel pump	58
Adjustments, service	6	Filter, oil	58
Air cleaner	54	Filters, carburetter	58
Alignment, front wheel	59	Fog lamp switch	9
		Free service, 500 miles	48
		Front dampers	59
		Front wheel alignment	59
		Front wheel hubs	57
		Fuel gauge	10
		Fuel pump filter	58
		Fuel tank, filling	16
		Fuses	36
		<b>G</b>	
		Gap, contact breaker	56
		Gap, sparking plug	56
		Gauge, fuel	10
		Gauge, oil pressure	8
		Gauge, water temperature	8
		Gear lever	6
		Gearbox drain plug	57
		Gearbox oil filler and dipstick	51
		Gearbox, steering	60
		General data	4
		Good driving	18
		<b>H</b>	
		Hand brake	6
		Hand brake cable	53
		Headlamp beam dip switch	6
		Headlamp bulb, fitting	37
		Headlamp light unit	37
		Headlamps, setting	38
		Heater controls	12
		Heater unit, draining	33
		Heating and demisting	12
		Hood, cleaning	30
		Hood, folding	29
		Hood, releasing	28
		Horn	8
		Hubs, front wheel	57
		<b>I</b>	
		Ignition control	42
		Ignition switch	10
		Ignition warning light	8
		Instruments	5
		<b>J</b>	
		Jack stowage	20
		Jacking up car, front	22
		Jacking up car, rear	22
		Jammed starter pinion	36
		<b>L</b>	
		Lamp, map-reading	11, 39
		Lamp, number-plate	38
		Lamp switch	9
		Lamps, fog, switch	9
		Lamps, panel	9, 39
		Lamps, pilot	38
		<b>E</b>	
Electrical equipment	35		
Engine and car numbers	3		
Engine drain tap	33		
Engine flushing	60		
Engine lubrication	54		

# INDEX

	Page		Page
Lamps, tail and stop	39	Spare wheel	22
Light unit, headlamp	37	Sparkling plugs	56
Lock release, bonnet	7	Specific gravity, checking	53
Lubrication, air cleaner	54	Speedometer	8
Lubrication, carburetters	52	Starter pinion jammed	36
Lubrication chart	64	Starter switch	9
Lubrication, distributor	55	Starting handle	20
Lubrication, dynamo	54	Starting up	18
Lubrication, engine	54	Steering column adjustment	6
Lubrication, front wheel hubs	57	Steering gear, lubrication	51
Lubrication, gearbox	51, 57	Steering gearbox	60
Lubrication, propeller shaft	51	Steering tie- and track-rods	51
Lubrication, rear axle	52, 57	Switch, direction indicator	10
Lubrication, steering gear	51	Switch, fog-lamp	9
Lubrication, steering gearbox	60	Switch, headlamp beam dip	6
Lubrication, steering tie- and track-rods	51	Switch, horn	8
Lubrication, swivel pins	51	Switch, ignition	10
Luggage and tools	19	Switch, lamp	9
Luggage boot, opening	20	Switch, panel lamp	9
		Switch, starter	9
		Switch, windshield wiper	11
		Switches	5
		Swivel pin lubrication	51
		<b>M</b>	
Main beam warning light	8		
Map-reading lamp	11, 39		
Mixture, adjusting	44, 45		
Mixture control	10		
		<b>O</b>	
Oil filter and dipstick, gearbox	51		
Oil filter, external	58		
Oil pressure gauge	8		
Optional equipment	12		
		<b>P</b>	
Panel lamp bulbs	39		
Panel lamp switch	9		
Pedals	6		
Periodical attention	48		
Pilot lamps	38		
Preparing for the road	15		
Propeller shaft universal joints	51		
		<b>R</b>	
Radiator drain tap	33		
Radiator, filling	16		
Rear axle drain plug	57		
Rear axle filter and level plug	52		
Rear brake adjustment	43		
Rear dampers	60		
Recommended lubricants	64		
Repairing tubes	24		
Replacement bulbs	39		
Revolution indicator	8		
Running in	18		
		<b>S</b>	
Safety catch, bonnet	16		
Seat adjustment	7		
Setting headlamps	38		
Sidesccreens	27, 28		
Slow-running adjustment	45		
		<b>T</b>	
Tail and stop lamps	39		
Temperature gauge	8		
Tools and luggage	19		
Top dead centre	42		
Topping up the battery	53		
Track- and tie-rods, steering	51		
Tubes, repairing	24		
Tyre care	24		
Tyre pressures, checking	17		
Tyre removal	24		
Tyre replacement	24		
Tyre valves	25		
Tyres and wheels	21		
		<b>U</b>	
Upholstery, cleaning	30		
		<b>V</b>	
Valve caps	25		
Valve clearances	42		
Valve interiors	25		
Valves, tyre	25		
		<b>W</b>	
Warming up	18		
Warning light, direction indicators	10		
Warning light, ignition	8		
Warning light, main beam	8		
Water pump lubrication	59		
Wheel alignment, front	59		
Wheel discs, removing	23		
Wheel hubs, lubrication	57		
Wheel, spare	22		
Wheels and tyres	21		
Wheels, removing	23		
Wheels, wire	26		
Windshield washer	14		
Windshield wiper blades	37		
Windshield wiper switch	11		
Wiring diagram	40		

## KEY TO RECOMMENDED LUBRICANTS

Component	A			B	C	D	E	F
	Engine and Air Cleaner							
Climatic conditions	Tropical and temperate down to 32° F. (0° C.)	Extreme cold down to 10° F. (-12° C.)	Arctic consistently below 10° F. (-12° C.)	All conditions down to 10° F. (-12° C.)	All conditions	All conditions	All conditions	All conditions
	Medium Filtrate 30	Zero Filtrate 20	Sub-Zero Filtrate 10W					
FILTRATE	Sternol W.W. 30	Zero Filtrate 20	Sub-Zero Filtrate 10W	Hypoid Filtrate Gear 90	Super Lithium Filtrate Grease	Super Lithium Filtrate Grease	Super Lithium Filtrate Grease	Zero Filtrate 20
STERNOL	Sternol W.W. 30	Sternol W.W. 20	Sternol W.W. 10	Ambroleum E.P. 90	Ambroline L.H.T.	Ambroline L.H.T.	Ambroline L.H.T.	Sternol W.W. 20
DUCKHAM'S	Duckham's NOL Thirty	Duckham's NOL Twenty	Duckham's NOL Ten	Duckham's Hypoid 90	Duckham's L.B. 10 Grease	Duckham's L.B. 10 Grease	Duckham's L.B. 10 Grease	Duckham's NOL Twenty
CASTROL	Castrol X.L.	Castrolite	Castrol Z	Castrol Hypoy	Castrolease L.M.	Castrolease L.M.	Castrolease L.M.	Castrolite
ESSO	Esso Extra Motor Oil 20W/30	Esso Extra Motor Oil 20W/30	Esso Motor Oil 10	Esso Expec Compound 90	Esso Multipurpose Grease H	Esso Multipurpose Grease H	Esso Multipurpose Grease H	Esso Extra Motor Oil 20W/30
MOBIL	Mobiloil A	Mobiloil Arctic	Mobiloil 10W	Mobilube G.X. 90	Mobilgrease M.P.	Mobilgrease M.P.	Mobilgrease M.P.	Mobiloil Arctic
BP ENERGOL	Energol S.A.E. 30	Energol S.A.E. 20W	Energol S.A.E. 10W	Energol E.P. S.A.E. 90	Energol L. 2	Energol L. 2	Energol L. 2	Energol S.A.E. 20W
SHELL	Shell X-100 30	Shell X-100 20/20W	Shell X-100 10W	Shell Spirax 90 E.P.	Shell Retinax A	Shell Retinax A	Shell Retinax A	Shell X-100 20/20W

